

Operation Manual

FLASH MEMORY MULTIMEDIA AV NAVIGATION
RECEIVER

AVIC-Z120BT AVIC-X920BT

Notice to all users:

This software requires that the navigation system is properly connected to your vehicle's parking brake and depending on your vehicle, additional installation may be required. For more information, please contact your Authorized Pioneer Electronics retailer or call us at (800) 421-1404.

Be sure to read **Important Information for the User** first!

Important Information for the User includes the important information that you must understand before using this navigation system.

Indications of this unit may be different from the actual value.

Some of the features of this device do not take in to consideration the type of vehicle it is installed into.

HD Radio
READY

SUPER  **TUNER III** **D**

English

Thank you for buying this Pioneer product.

Please read through these operating instructions so you will know how to operate your model properly. *After you have finished reading the instructions, keep this manual in a safe place for future reference.*



Important

The screens shown in the examples may differ from actual screens.
Actual screens may be changed without notice for performance and function improvements.

01 Introduction

- Manual overview **9**
 - How to use this manual **9**
 - Conventions used in this manual **9**
 - Terms used in this manual **9**
- Notice regarding video viewing **10**
- Notice regarding DVD Video viewing **10**
- Notice regarding MP3 file usage **10**
- iPod compatibility **10**
- Map coverage **10**
- Protecting the LCD panel and screen **11**
- Notes on internal memory **11**
 - Before removing the vehicle battery **11**
 - Data subject to erasure **11**

02 Basic operation

- Checking part names and functions **12**
- Adjusting the LCD panel angle **14**
- Inserting and ejecting a disc **14**
 - Inserting a disc (for AVIC Z120BT) **14**
 - Ejecting a disc (for AVIC Z120BT) **15**
 - Inserting a disc (for AVIC X920BT) **15**
 - Ejecting a disc (for AVIC X920BT) **15**
- Inserting and ejecting an SD memory card **15**
 - Inserting an SD memory card (for AVIC Z120BT) **15**
 - Ejecting an SD memory card (for AVIC Z120BT) **16**
 - Inserting an SD memory card (for AVIC X920BT) **17**

- Ejecting an SD memory card (for AVIC X920BT) **17**
- Plugging and unplugging a USB storage device **18**
 - Plugging in a USB storage device **18**
 - Unplugging a USB storage device **18**
- Connecting and disconnecting an iPod **18**
 - Connecting your iPod **19**
 - Disconnecting your iPod **19**
- Flow from startup to termination **19**
- On first time startup **19**
- Regular startup **20**

03 How to use the navigation menu screens

- Screen switching overview **22**
- What you can do on each menu **23**
- Shortcut Menu **23**
 - Selecting the shortcut **23**
 - Canceling the shortcut **24**
- Operating list screens (e.g. POI list) **24**
- Operating the on screen keyboard **24**

04 How to use the map

- How to read the map screen **25**
 - Enlarged map of the intersection **26**
 - Display during freeway driving **27**
- Roads without turn by turn instructions **27**
- Operating the map screen **27**
 - Changing the scale of the map **27**
 - Switching the map orientation **27**
 - Scrolling the map to the position you want to see **28**
 - Setting the "Quick Access" menu **28**
- Switching the view mode **29**

05 Eco-driving function

- Displaying "Eco Graph" **31**
- Displaying Eco Drive Level guidance **32**
- Sudden start alert **32**

06 Searching for and selecting a location

- The basic flow of creating your route **33**
- Searching for a location by address **34**

- Searching for a city name first **34**
- Finding the location by specifying the house number **35**
- Searching for a name by entering multiple keywords **36**
- Setting up a route to your home **36**
- Searching for Points of Interest (POI) **36**
 - Searching for POIs by preset categories **36**
 - Searching for a POI directly from the name of the facilities **37**
 - Searching for a nearby POI **37**
 - Searching for POIs around the destination **38**
 - Searching for POIs around the city **38**
- Selecting destination from "Favorites" **39**
- Searching for POIs by using the data on the SD memory card **39**
- Selecting a location you searched for recently **39**
- Searching for a location by coordinates **40**
- 07 After the location is decided**
 - Setting a route to your destination **41**
 - Displaying multiple routes **41**
- 08 Checking and modifying the current route**
 - Displaying the "Route Overview" screen **42**
 - Modifying the route calculation conditions **42**
 - Items that users can operate **42**
 - Checking the current itinerary **43**
 - Editing waypoints **44**
 - Adding a waypoint **44**
 - Deleting a waypoint **44**
 - Sorting waypoints **45**
 - Canceling the route guidance **45**
- 09 Registering and editing locations**
 - Storing a location in "Favorites" **46**
 - Registering a location by "Favorites" **46**
 - Registering a location by scroll mode **46**
 - Editing registered locations **46**
 - Editing the entry in the "Favorites" list **46**
 - Editing your home **47**
 - Sorting the entry in the "Favorites" list **47**
 - Deleting the entry from the "Favorites" list **48**
 - Exporting and importing "Favorites" items **48**
 - Exporting "Favorites" items **48**
 - Importing the "Favorites" items **49**
 - Deleting the entry from the "History" list **49**
- 10 Browsing information on MSN Direct**
 - Activating the service **50**
 - Checking your product key **50**
 - Subscribing to the MSN Direct service **51**
 - Activating the MSN Direct function **51**
 - Browsing gas prices **51**
 - Browsing movie times **52**
 - Searching for a theater by selecting a movie title **52**
 - Searching for a movie title by selecting a theater **53**
 - Browsing weather information **54**
 - Checking the local weather information **54**
 - Checking worldwide weather conditions **54**
 - How to read MSN Direct information on the map **54**
 - Using traffic information **55**
 - Checking all traffic information **55**
 - Checking traffic information on the route **56**

How to read traffic information on the map **56**

Viewing the traffic flow **57**

Setting an alternative route to avoid traffic congestion **58**

Selecting traffic information to display **59**

Browsing local events **59**

Browsing news headlines **60**

Browsing stock quotes **61**

Selecting stock symbols **61**

Viewing the detailed stock quotes **61**

Deleting registered stocks **62**

11 Registering and connecting a Bluetooth device

Preparing communication devices **63**

Registering your Bluetooth devices **63**

Searching for nearby Bluetooth devices **63**

Pairing from your Bluetooth devices **64**

Searching for a specified Bluetooth device **65**

Deleting a registered device **66**

Connecting a registered Bluetooth device **66**

Setting for priority connecting **67**

12 Using hands-free phoning

Displaying the Phone Menu **68**

Making a phone call **68**

Direct dialing **68**

Making a call home easily **69**

Calling a number in the "Contacts List" **69**

Dialing from the history **69**

Dialing GOOG 411 **70**

Dialing the entry stored in the "Favorites" list **70**

Dialing a facility's phone number **70**

Dialing from the map **71**

Receiving a phone call **71**

Answering an incoming call **71**

Transferring the phone book **72**

Deleting registered contacts **73**

Changing the phone settings **73**

Editing the device name **73**

Editing the password **73**

Stopping Bluetooth wave transmission **73**

Echo canceling and noise reduction **74**

Answering a call automatically **74**

Setting the automatic rejection function **74**

Clearing memory **75**

Updating the Bluetooth wireless technology software **75**

Notes for hands free phoning **75**

13 Basic operations of the AV source

Displaying the AV operation screen **77**

Selecting a source **77**

Operating list screens (e.g. iPod list screen) **77**

Switching between the AV operation screen and the list screen **77**

Selecting an item **78**

Returning to the previous display **78**

14 Using the radio (FM)

Starting procedure **79**

Reading the screen **79**

Using the touch panel keys **80**

Storing and recalling broadcast frequencies **80**

Using the "Function" menu **81**

Storing the strongest broadcast frequencies **81**

Tuning in strong signals **81**

15 Using the radio (AM)

Starting procedure **83**

- Reading the screen **83**
- Using the touch panel keys **84**
 - Storing and recalling broadcast frequencies **84**
- Using the "Function" menu **85**
 - Stores the strongest broadcast frequencies **85**
 - Tunes in strong signals **85**
- 16 HD Radio™ reception**
 - Starting procedure **86**
 - Reading the screen **86**
 - Using the touch panel keys **87**
 - Storing and recalling broadcast frequencies **87**
 - Switching the display **88**
 - Scrolling the detailed information **88**
 - Using the "Function" menu **88**
 - Storing the strongest broadcast frequencies **88**
 - Switching the seek mode **89**
 - Tuning in strong signals **89**
 - Switching the reception mode **89**
- 17 Playing audio CDs**
 - Starting procedure **90**
 - Reading the screen **90**
 - Using the touch panel keys **91**
 - Using the "Function" menu **92**
- 18 Playing music files on ROM**
 - Starting procedure **93**
 - Reading the screen **93**
 - Using the touch panel keys **95**
 - Using the "Function" menu **96**
- 19 Playing a DVD-Video**
 - Starting procedure **97**
 - Reading the screen **97**
 - Using the touch panel keys **98**
 - Resuming playback (Bookmark) **99**
 - Searching for a specific scene and starting playback from a specified time **100**
 - Direct number search **100**
 - Operating the DVD menu **100**
 - Using DVD menu by touch panel keys **100**
 - Frame by frame playback **101**
 - Slow motion playback **101**
 - Using the "Function" menu **101**
- 20 Playing a DivX video**
 - Starting procedure **103**
 - Reading the screen **103**
 - Using the touch panel keys **104**
 - Frame by frame playback **105**
 - Slow motion playback **105**
 - Starting playback from a specified time **106**
 - Using the "Function" menu **106**
- 21 DVD-Video or DivX setup**
 - Displaying DVD/DivX® Setup menu **107**
 - Setting the top priority languages **107**
 - Setting the angle icon display **107**
 - Setting the aspect ratio **107**
 - Setting the parental lock **108**
 - Setting the code number and level **108**
 - Setting the auto play **109**
 - Setting the subtitle file for DivX **109**
 - Language code chart for DVDs **110**
- 22 Playing music files (from USB or SD)**
 - Starting procedure **111**
 - Reading the screen **111**
 - Using the touch panel keys (Music) **113**
 - Using the "Function" menu **114**
- 23 Playing video files (from USB or SD)**
 - Starting procedure **115**
 - Reading the screen **115**
 - Using the touch panel keys (Video) **116**

Searching for a specific scene and starting playback from a specified time **117**

Using the "Function" menu **117**

24 Using an iPod (iPod)

Starting procedure **118**

Reading the screen **118**

Using the touch panel keys **120**

Starting the video playback **122**

Narrowing down a song or video with the list **122**

Operating the functions from your iPod **123**

Playing MusicSphere **124**

Reading the screen **124**

Using the touch panel keys **124**

Using the "Function" menu **124**

25 Using Pandora®

Starting procedure **126**

Reading the screen **127**

Using the touch panel keys **128**

26 Using the Bluetooth audio player

Starting procedure **129**

Reading the screen **129**

Using the touch panel keys **131**

Using the "Function" menu **131**

27 Using the XM tuner

Starting procedure **133**

Reading the screen **133**

Using the touch panel keys **135**

Selecting an XM channel directly **136**

Displaying the Radio ID **136**

Storing and recalling broadcast stations **136**

Selecting a channel from the list **137**

Using "My Mix" function **137**

Using the "Function" menu **138**

Setting the memorized songs **138**

28 Using the SIRIUS tuner

Starting procedure **139**

Reading the screen **139**

Using the touch panel keys **140**

Selecting a SIRIUS channel directly **141**

Display the Radio ID **141**

Storing and recalling broadcast stations **141**

Using "My Mix" function **142**

Using the "Instant Replay" function **142**

Using the "Function" menu **143**

Setting the memorized songs **143**

Using the Game Alert function **144**

Displaying Game Information **144**

29 Using AV input

Reading the screen **145**

Using AV1 **145**

Using AV2 **145**

Using the touch panel keys **145**

30 Using the external unit (EXT1, EXT2)

Starting procedure **146**

Reading the screen **146**

Using the touch panel keys **147**

31 Customizing preferences

Displaying the "Navi Settings" screen **148**

Checking the connections of leads **148**

Checking sensor learning status and driving status **149**

Clearing status **149**

Using the "Gas Mileage" function **150**

Inputting the fuel consumption information for calculating the fuel cost **150**

Calculating the fuel consumption **151**

Exporting the data of fuel cost information **151**

Recording your travel history **152**

- Using the demonstration guidance **152**
- Registering your home **152**
- Correcting the current location **153**
- Changing the eco function setting **153**
- Displaying the "Map Settings" screen **154**
- Setting the auto zoom display **154**
- Setting the detailed city map **155**
- Setting the barrier graphic for city map **155**
- Displaying the traffic notification icon **155**
- Displaying the Bluetooth connection icon **156**
- Setting the current street name display **156**
- Setting the "Favorites" icon display **156**
- Displaying the 3D landmarks **156**
- Displaying maneuvers **157**
- Displaying the MSN Direct icons **157**
- Displaying the fuel consumption information **157**
- Displaying POI on the map **157**
 - Displaying preinstalled POIs on the map **157**
 - Displaying the customized POIs **158**
- Changing "View Mode" **159**
- Setting the map color change between day and night **159**
- Changing the road color **159**
- Changing the setting of navigation interruption screen **160**
- Selecting the "Quick Access" menu **160**
- Displaying the "System Settings" screen **161**
 - Customizing the regional settings **161**
 - Setting the Volume for Guidance and Phone **163**
 - Changing the preinstalled splash screen **163**
 - Changing to the splash screen stored in the SD memory card **164**
 - Setting for rear view camera **164**
 - Adjusting the response positions of the touch panel (touch panel calibration) **165**
 - Setting the illumination color **165**
 - Checking the version information **166**
- Selecting the video for "Rear display" **166**
- Adjusting the picture **167**
- Displaying the "AV System Settings" screen **168**
 - Setting video input 1 (AV1) **168**
 - Setting video input 2 (AV2) **168**
 - Changing the wide screen mode **169**
 - Setting the rear output **169**
 - Switching the muting/attenuation timing **170**
 - Switching the muting/attenuation level **170**
 - Acquiring/Cataloging iPod music information **170**
 - Displaying your DivX VOD registration code **171**
- Displaying the "AV Sound Settings" screen **171**
 - Using balance adjustment **172**
 - Using the equalizer **172**
 - Adjusting loudness **174**
 - Using subwoofer output **174**
 - Using the high pass filter **175**
 - Adjusting source levels **175**
 - Enhancing bass (Bass Booster) **175**
 - Setting the simulated sound stage **175**
- Replicating the settings **176**
- Turning off the screen **177**

32 Operating Your Navigation System with Voice

- To Ensure Safe Driving **178**
- Basics of Voice Operation **178**
 - Flow of voice operation **178**
 - Starting voice operation **178**
 - How to use the voice operation **179**

- Available Basic Voice Commands **181**
 - Basic commands **181**
 - Voice operation for the iPod **181**
 - Voice operation for AV source (other than iPod) **182**
 - Voice commands related to hands free phoning **183**
- Tips for Voice Operation **184**

33 Other functions

- Setting the anti theft function **185**
 - Setting the password **185**
 - Entering the password **185**
 - Deleting the password **185**
 - Forgotten password **185**
- Returning the navigation system to the default or factory settings **186**
 - Setting items to be deleted **187**
 - Restore Factory Settings **188**
 - Displaying the "Select Items to Reset" screen **188**

Appendix

- Troubleshooting **189**
- Messages and how to react to them **194**
- Messages for audio functions **196**
- Positioning technology **198**
 - Positioning by GPS **198**
 - Positioning by dead reckoning **198**
 - How do GPS and dead reckoning work together? **198**
- Handling large errors **199**
 - When positioning by GPS is impossible **199**
 - Conditions likely to cause noticeable positioning errors **200**
- Route setting information **202**
 - Route search specifications **202**
- Handling and care of discs **202**
 - Built in drive and care **203**
 - Ambient conditions for playing a disc **203**

- Playable discs **203**
 - DVD Video and CD **203**
 - AVCHD recorded discs **203**
 - Playing DualDisc **204**
 - Dolby Digital **204**
 - DTS sound **204**
- Detailed information for playable media **204**
 - Compatibility **204**
 - Media compatibility chart **207**
- Bluetooth **211**
 - About the SAT RADIO READY Logo **211**
 - HD Radio Technology **211**
 - SD and SDHC logo **212**
 - WMA/WMV **212**
 - DivX **212**
 - AAC **213**
- Detailed information regarding connectable iPods **213**
 - iPod **213**
 - iPhone **213**
 - iTunes **213**
- Using the LCD screen correctly **213**
 - Handling the LCD screen **213**
 - Liquid crystal display (LCD) screen **214**
 - Maintaining the LCD screen **214**
 - LED (light emitting diode) backlight **214**
- Display information **215**
 - Destination Menu **215**
 - Phone Menu **215**
 - Settings Menu **216**
- Glossary **220**
- Specifications **223**

Introduction

Manual overview

Before using this product, be sure to read **Important Information for the User** (a separate manual) which contains warnings, cautions, and other important information that you should note.

How to use this manual

Finding the operation procedure for what you want to do

When you have decided what you want to do, you can find the page you need from the *Contents*.

Finding the operation procedure from a menu name

If you want to check the meaning of an item displayed on the screen, you will find the necessary page from the *Display information* at the end of the manual.

Glossary

Use the glossary to find the meanings of terms.

Conventions used in this manual

Before moving on, take a few minutes to read the following information about the conventions used in this manual. Familiarity with these conventions will help you greatly as you learn how to use your new equipment.

- Buttons on your navigation system are described in **ALL CAPITAL, BOLD** lettering: e.g.) **MENU** button, **MAP** button.
- Items in different menus, screen titles, and functional components are described in **bold** with double quotation marks “ ”: e.g.) “**Destination Menu**” screen or “**AV Source**” screen
- Touch panel keys that are available on the screen are described in **bold** in brackets []:

e.g.)

[**Destination**], [**Settings**].

- Extra information, alternatives and other notes are presented in the following format: e.g.)
 - ☐ If the home location has not been stored yet, set the location first.
- Descriptions of separate operations to be performed on the same screen are indicated with ■ at the beginning of the description: e.g.)
 - Touch [**OK**].
- References are indicated like this: e.g.)
 - ➔ For details, refer to *How to use the navigation menu screens* on page 22.

Terms used in this manual

“Front Display” and “Rear Display”

In this manual, the screen that is attached to the body of this navigation unit will be referred to as the “Front Display”. Any additional optional screen that is purchased for use in conjunction with this navigation unit will be referred to as the “Rear Display”.

“Video image”

“Video image” in this manual indicates moving images of DVD Video, DivX®, iPod, and any equipment that is connected to this system with an RCA cable, such as general purpose AV equipment.

“External storage device (USB, SD)”

The SD memory card, SDHC memory card, microSD card, microSDHC card and USB memory device are collectively referred to as the “external storage device (USB, SD)”. If it indicates the USB memory only, it is referred to as the “USB storage device”.

“SD memory card”

The SD memory card, SDHC memory card, microSD card and microSDHC card are collectively referred to as the “SD memory card”.

Notice regarding video viewing

Remember that use of this system for commercial or public viewing purposes may constitute an infringement on the author’s rights as protected by the Copyright Law.

Notice regarding DVD-Video viewing

This product incorporates copyright protection technology that is protected by method claims of certain U.S. patents and other intellectual property rights owned by Macrovision Corporation and other rights owners. Use of this copyright protection technology must be authorized by Macrovision Corporation, and is intended for home and other limited viewing uses only unless otherwise authorized by Macrovision Corporation. Reverse engineering or disassembly is prohibited.

Notice regarding MP3 file usage

Supply of this navigation system conveys only a license for private, non commercial use and does not convey a license nor imply any right to use this product in any commercial (i.e. revenue generating), real time broadcasting (terrestrial, satellite, cable and/or any other media), broadcasting/streaming via internet, intranets and/or other networks or in other electronic content distribution systems, such as pay audio or audio on demand applications. An independent license for such use is

required. For details, please visit <http://www.mp3licensing.com>.

iPod compatibility

This product supports only the following iPod models and iPod software versions. Others may not work correctly.

- iPod nano first generation: Ver. 1.3.1
 - iPod nano second generation: Ver. 1.1.3
 - iPod nano third generation: Ver. 1.1.3
 - iPod nano fourth generation: Ver. 1.0.3
 - iPod nano fifth generation: Ver. 1.0.1
 - iPod fifth generation: Ver. 1.3
 - iPod classic: Ver. 2.0.2
 - iPod touch first generation: Ver. 3.1.1
 - iPod touch second generation: Ver. 3.1.1
 - iPhone: Ver. 3.1.2
 - iPhone 3G: Ver. 3.1.2
 - iPhone 3GS: Ver. 3.1.2
- In this manual, iPod and iPhone will be referred to as iPod.
- When you use this navigation system with a Pioneer USB interface cable for iPod (CD IU50V) (sold separately), you can control an iPod compatible with this navigation system.
- To obtain maximum performance, we recommend that you use the latest software for the iPod.
- Operation methods may vary depending on the iPod models and the software version of iPod.
- For details about iPod compatibility with this navigation system, refer to the information on our website.
- iPod is a trademark of Apple Inc., registered in the U.S. and other countries.
- iPhone is a trademark of Apple Inc.

Map coverage

For details about the map coverage of this navigation system, refer to the information on our website.

Protecting the LCD panel and screen

- ❑ Do not allow direct sunlight to fall on the LCD screen when this product is not being used. Extended exposure to direct sunlight can result in LCD screen malfunction due to the resulting high temperatures.
- ❑ When using a cellular phone, keep the antenna of the cellular phone away from the LCD screen to prevent disruption of the video in the form of spots, colored stripes, etc.
- ❑ To protect the LCD screen from damage, be sure to touch the touch panel keys with your finger only and gently touch the screen. ■

ing the navigation system to the default or factory settings on page 186. ■

Notes on internal memory

Before removing the vehicle battery

If the battery is disconnected or discharged, the memory will be erased and must be reprogrammed.

- ❑ Some data remains. Be sure to read *Returning the navigation system to the default or factory settings* first.
 - ➔ For detailed information about the items which would be erased, refer to *Returning the navigation system to the default or factory settings* on page 186.

Data subject to erasure

The information is erased by disconnecting the yellow lead from the battery (or removing the battery itself). However, some items remain.

- ❑ Some data remains. Be sure to read *Returning the navigation system to the default or factory settings* first.
 - ➔ For detailed information about the items which would be erased, refer to *Returning*

Checking part names and functions

This chapter gives information about the names of the parts and the main features using the buttons.

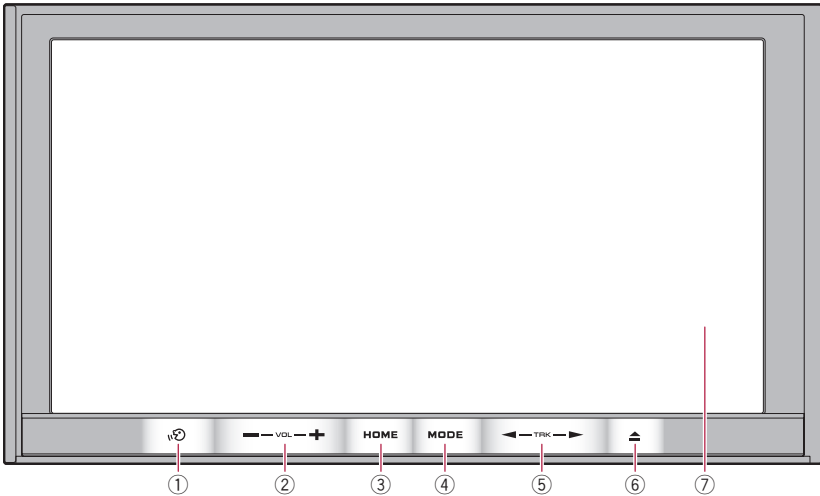

AVIC-Z120BT (with the LCD panel closed)

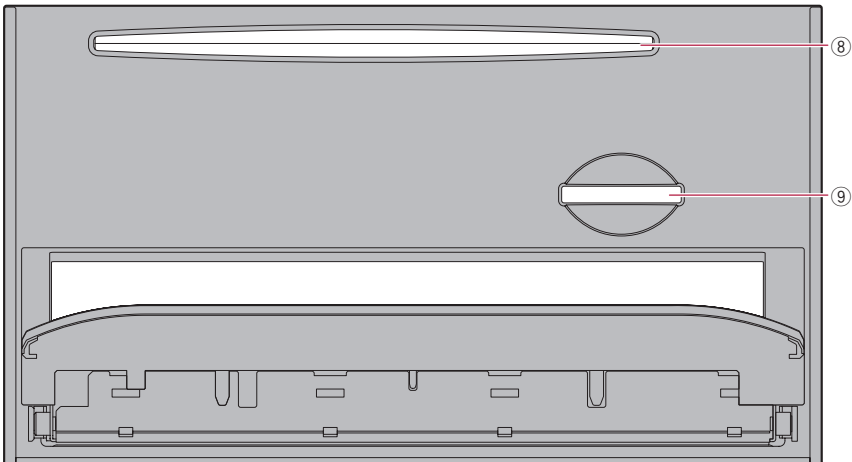

AVIC-Z120BT (with the LCD panel open)

Basic operation

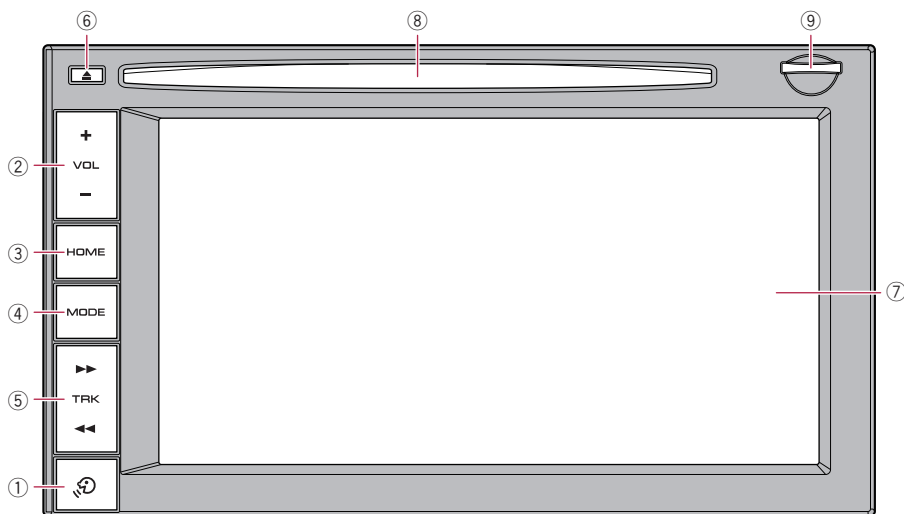

AVIC-X920BT

- ① **voice operation button**
Press the button to activate voice operations.
Press and hold the button to switch the AV source to mute.
To cancel the muting, press and hold it again.
 - ② **VOL (+/-) button**
Press to adjust the AV (Audio and Video) source volume.
 - ③ **HOME button**
 - Press the **HOME** button to display the “**Top Menu**” screen.
 - Press to switch between the “Classic Menu” and the “Shortcut Menu” while the “**Top Menu**” is displayed.
 - ➡ For details, refer to *What you can do on each menu* on page 23.
 - Press and hold to turn off the screen display.
 - ④ **MODE button**
 - Press to switch between the map screen and the AV operation screen.
 - ⑤ **TRK button**
Press to perform manual seek tuning, fast forward, reverse and track search controls.
➡ For details, refer to the descriptions from Chapter 14 to Chapter 30.
 - ⑥ **▲ button**
 - ⑦ **LCD screen**
 - ⑧ **Disc loading slot**
Insert a disc to play.
➡ For details of the operation, refer to *Inserting and ejecting a disc* on the next page.
 - ⑨ **SD card slot**
➡ For more detailed information, refer to *Inserting and ejecting an SD memory card* on page 15.
- Press to display the map screen while the navigation function screen is displayed.
 - Press and hold to display the “**Picture Adjustment**” screen.
➡ For details, refer to *Adjusting the picture* on page 167.

Adjusting the LCD panel angle

- This function is available for AVIC Z120BT only.

! WARNING

When opening, closing and adjusting the angle of the LCD panel, be careful not to get your fingers caught.

! CAUTION

Do not open or close the LCD panel by force. This may cause malfunction.

1 Press the **▲** button.

The **"Monitor Setup"** screen appears.

2 Touch **↙** or **↘** to adjust the angle.

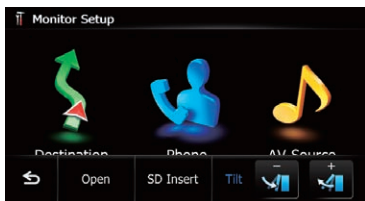

3 Touch **↻**.

- The adjusted angle of the LCD panel will be memorized and the LCD panel will automatically return to that angle the next time the LCD panel is opened or closed. □

Inserting and ejecting a disc

Inserting a disc (for AVIC-Z120BT)

- This section describes operations for AVIC Z120BT.

! WARNING

- When opening, closing and adjusting the angle of the LCD panel, be careful not to get your fingers caught.

- Do not use with the LCD panel left open. If LCD panel is left open, it may result in injury in the event of an accident.

! CAUTION

- Do not open or close the LCD panel by force. This may cause malfunction.
- Do not operate this navigation system until the LCD panel completely opens or closes. If this navigation system is operated while the LCD panel is opening or closing, the LCD panel may stop at that angle for safety.
- Do not place a glass or a can on the open LCD panel. Doing so may break this navigation system.
- Do not insert anything other than a disc into the disc loading slot.

1 Press the **▲** button.

The **"Monitor Setup"** screen appears.

2 Touch **[Open]**.

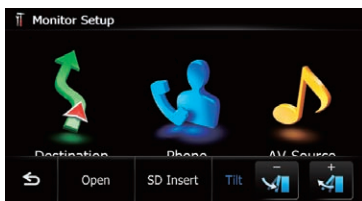

The LCD panel opens, and the disc loading slot appears.

3 Insert a disc into the disc loading slot.

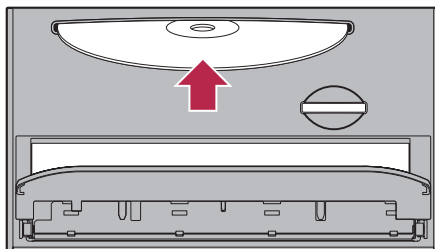

The disc is loaded, and the LCD panel closes.

Basic operation

Ejecting a disc (for AVIC-Z120BT)

❑ This section describes operations for AVIC Z120BT.

1 Press the **▲** button.

The "Monitor Setup" screen appears.

2 Touch [Disc Eject].

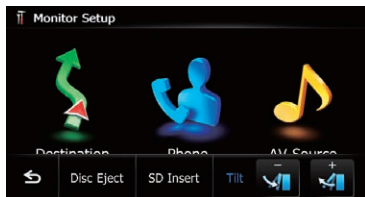

The LCD panel opens, and the disc is ejected.

3 Remove the disc, and press the **▲** button.

The LCD panel closes.

Inserting a disc (for AVIC-X920BT)

❑ This section describes operations for AVIC X920BT.

● Insert a disc into the disc loading slot.

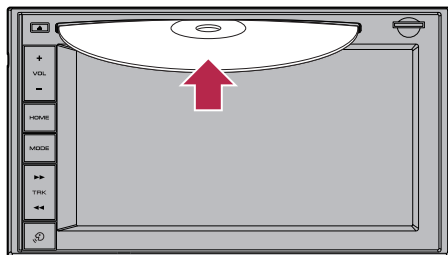

❑ Do not insert anything other than a disc into the disc loading slot.

Ejecting a disc (for AVIC-X920BT)

❑ This section describes operations for AVIC X920BT.

1 Press the **▲** button.

The touch panel keys for ejecting the media appear.

2 Touch [Disc Eject].

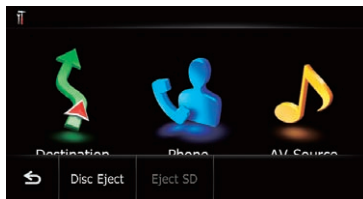

The disc is ejected.

Inserting and ejecting an SD memory card

⚠ WARNING

Ejecting an SD memory card during data transfer can damage the SD memory card. Be sure to eject the SD memory card by following the procedure described in this manual.

⚠ CAUTION

If data loss or corruption occurs on the storage device for any reason, it is usually not possible to recover the data. Pioneer accepts no liability for damages, costs or expenses arising from data loss or corruption.

- ❑ This system is not compatible with Multi Media Card (MMC).
- ❑ Compatibility with all SD memory cards is not guaranteed.
- ❑ This unit may not achieve optimum performance with some SD memory cards.

Inserting an SD memory card (for AVIC-Z120BT)

❑ This section describes operations for AVIC Z120BT.

⚠ CAUTION

- Do not press the **▲** button when an SD memory card is not fully inserted. Doing so may damage the card.
- Do not press the **▲** button before an SD memory card has been completely removed. Doing so may damage the card.

1 Press the **▲** button.

The “**Monitor Setup**” screen appears.

2 Touch [SD Insert].

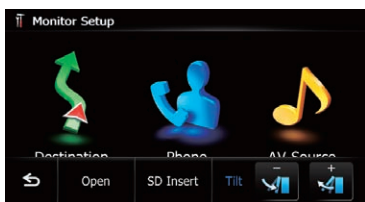

The LCD panel opens, and the SD card slot appears.

3 Insert an SD memory card into the SD card slot.

Insert it with the label surface facing to the up side and press the card until it clicks and completely locks.

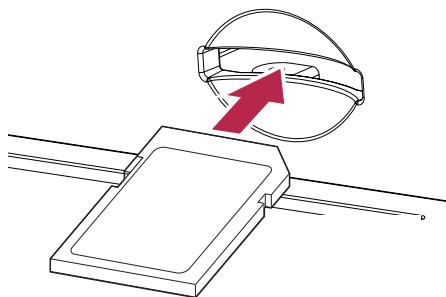

4 Press the **▲** button.

The LCD panel closes.

- If data related to map data, such as customized POI data, is stored on the SD memory card, the navigation system restarts.

Ejecting an SD memory card (for AVIC-Z120BT)

- This section describes operations for AVIC Z120BT.

1 Press the **▲** button.

The “**Monitor Setup**” screen appears.

2 Touch [Eject SD].



The LCD panel opens.

- Touch [Yes] if the message indicating that the flap opens after the navigation system restarts appears.



The navigation system restarts, and then the LCD panel opens.

3 Press the middle of the SD memory card gently until it clicks.

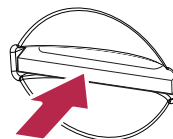

Basic operation

4 Pull the SD memory card out straight.

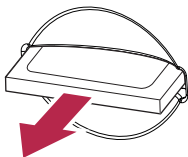

5 Press the ▲ button.

The LCD panel closes.

- ❑ If data related to map data, such as customized POI data, is stored on the SD memory card, the navigation system restarts.
- ❑ When you eject the SD memory card by touching [Eject SD], the model information that you are using will be automatically stored into the SD memory card. The utility program AVIC FEEDS will use this information to recognize the model that you use.

Inserting an SD memory card (for AVIC-X920BT)

- ❑ This section describes operations for AVIC X920BT.

● Insert an SD memory card into the SD card slot.

Insert the SD memory card with the terminal contacts facing down, and press the card until it clicks and locks completely.

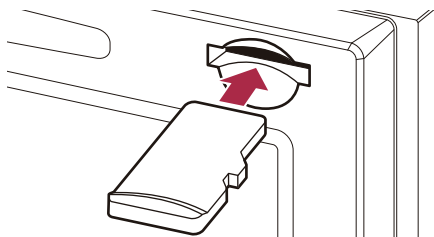

- ❑ If data related to map data, such as customized POI data, is stored on the SD memory card, the navigation system restarts.

Ejecting an SD memory card (for AVIC-X920BT)

- ❑ This section describes operations for AVIC X920BT.

1 Press the ▲ button.

The touch panel keys for ejecting the media appear.

2 Touch [Eject SD].



A message prompting you to remove the SD memory card appears.

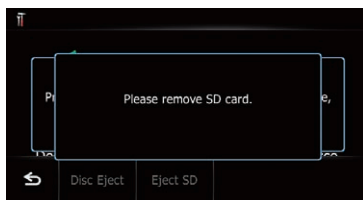

3 Press the middle of the SD memory card gently until it clicks.



4 Pull the SD memory card out straight.



When the data related to map data is stored

If data related to map data, such as customized POI data, is stored on the SD memory card, operating procedures are slightly different.

1 Press the **▲** button and then touch [Eject SD].

2 Touch [Yes].

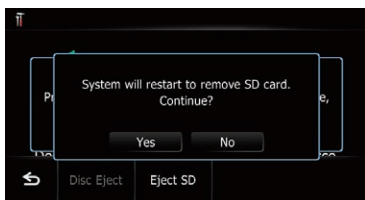

The navigation system restarts, and a message prompting you to remove the SD memory card appears.



3 Eject the SD memory card while the message is displayed.

Eject the SD memory card before touching [OK].

4 Touch [OK].

The navigation system restarts.

Plugging and unplugging a USB storage device

⚠ CAUTION

- To prevent data loss and damage to the storage device, never remove it from this navigation system while data is being transferred.

- If data loss or corruption occurs on the storage device for any reason, it is usually not possible to recover the data. Pioneer accepts no liability for damages, costs or expenses arising from data loss or corruption.

Plugging in a USB storage device

- Plug a USB storage device into the USB connector.

USB connector

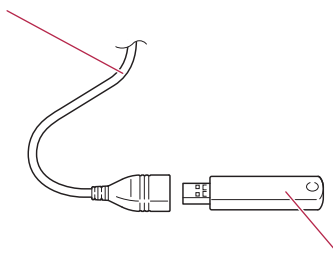

USB storage device

- Compatibility with all USB storage devices is not guaranteed. This navigation system may not achieve optimum performance with some USB storage devices.
- Connection via a USB hub is not possible.

Unplugging a USB storage device

- Pull out the USB storage device after checking that no data is being accessed.

Connecting and disconnecting an iPod

⚠ CAUTION

- To prevent data loss and damage to the storage device, never remove it from this navigation system while data is being transferred.

Basic operation

- If data loss or corruption occurs on the storage device for any reason, it is usually not possible to recover the data. Pioneer accepts no liability for damages, costs or expenses arising from data loss or corruption.

Connecting your iPod

Using the USB interface cable for iPod enables you to connect your iPod to the navigation system.

- A USB interface cable for iPod (CD IU50V) (sold separately) is required for connection.

1 Pull out the USB storage device after checking that no data is being accessed.

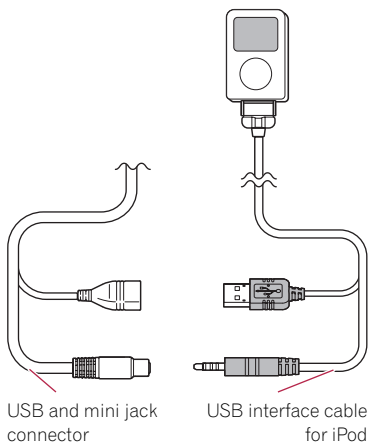

- For details about iPod compatibility with this navigation system, refer to the information on our website.
- Connection via a USB hub is not possible.

2 Connect your iPod.

Disconnecting your iPod

- Pull out the USB interface cable for iPod after checking that no data is being accessed. □

Flow from startup to termination

1 Start the engine to boot up the system.

After a short pause, the splash screen comes on for a few seconds.

- To protect the LCD screen from damage, be sure to touch the touch panel keys with your finger only and gently touch the screen.

2 Turn off the vehicle engine to terminate the system.

The navigation system is also turned off. □

On first-time startup

When you use the navigation system for the first time, select the language that you want to use.

1 Start the engine to boot up the system.

After a short pause, the splash screen comes on for a few seconds.

2 Touch the language that you want to use on the screen.

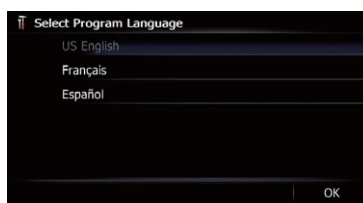

3 Touch the language that you want to use for the voice guidance.



The navigation system will now restart.

4 Read the disclaimer carefully, checking its details, and then touch [OK] if you agree to the conditions.



The map screen appears.

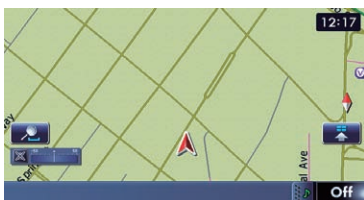

Regular startup

● Start the engine to boot up the system.

After a short pause, the splash screen comes on for a few seconds.

- The screen shown will differ depending on the previous conditions.
- When there is no route, the disclaimer appears after the navigation system reboots. Read the disclaimer carefully, checking its details, and then touch **[OK]** if you agree to the conditions.
- If the anti theft function is activated, you must enter your password. Read the disclaimer carefully, checking its details, and then touch **[OK]** if you agree to the conditions. 

Basic operation

Screen switching overview

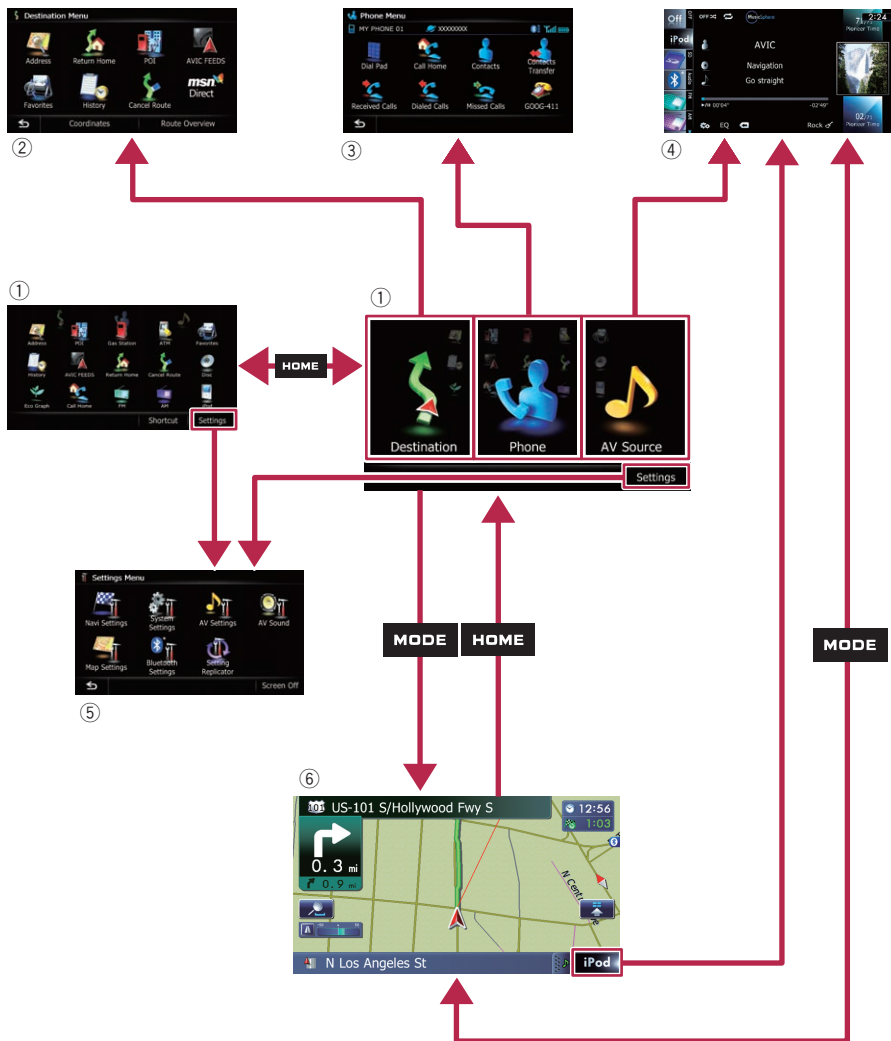

How to use the navigation menu screens

What you can do on each menu

① Top Menu

Press the **HOME** button to display the "**Top Menu**" screen.

This is the starting menu to access the desired screens and operate the various functions.

There are two types of the "**Top Menu**" screen.

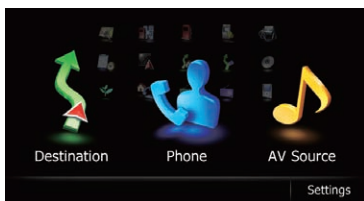

Classic Menu

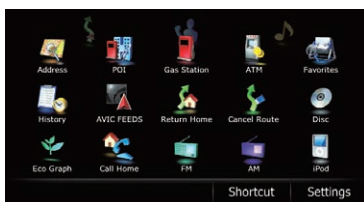

Shortcut Menu

□ In this manual, Classic Menu will be referred to as "**Top Menu**".

② Destination Menu

You can search for your destination on this menu. You can also check or cancel your set route from this menu.

③ Phone Menu

You can access the screen that is related to hands free phoning.

④ AV operation screen

This is the screen that normally appears when you play the AV source.

⑤ Settings Menu

You can access the screen to customize settings.

⑥ Map screen

Press the **MODE** button to display the navigation map screen. □

Shortcut Menu

Registering your favorite menu items in shortcuts allows you to quickly jump to the registered menu screen by a simple touch on the Shortcut Menu screen.

Selecting the shortcut

□ Up to 15 menu items can be registered in shortcuts.

1 Press the HOME button repeatedly to display the "Shortcut Menu" screen.

□ When you use the navigation system for the first time or no items are set on shortcut, a message will appear. Touch **[Yes]** to proceed to next step.

2 Touch [Shortcut].

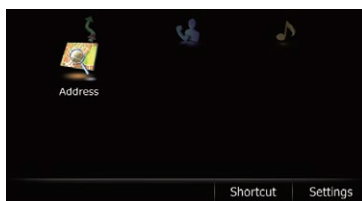

The Shortcut selection screen appears.

3 Touch the tab on the right edge or scroll the bar to display the icon that you want to set to shortcut.

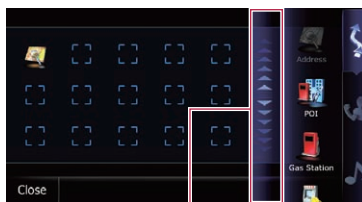

Scroll bar

4 Touch and hold the icon that you want to add to shortcut.

How to use the navigation menu screens

5 Move the icon to the left side of the screen, and then release it.

The selected item is added to shortcut.

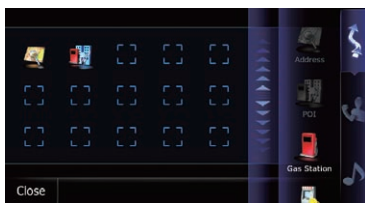

Canceling the shortcut

1 Touch and hold the icon that you want to cancel the shortcut.

2 Move the icon to the right side of the screen, and then release it.

Operating list screens (e.g. POI list)

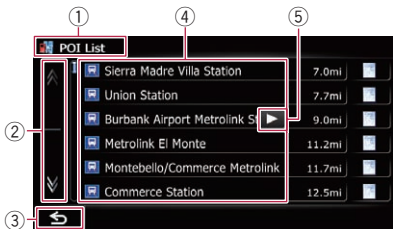

① **Screen title**

②

Touching or on the scroll bar scrolls through the list and allows you to view the remaining items.

③

Returns the previous screen.

④ **Listed items**

Touching an item on the list allows you to narrow down the options and proceed to the next operation.

⑤

If all of the characters cannot be displayed within the displayed area, touching the key to

the right of the item allows you to see remaining characters.

Operating the on-screen keyboard



① **Screen title**

The screen title appears.

② **Text box**

Displays the characters that are entered. If there is no text in the box, an informative guide with text appears.

③ **Keyboard**

Touch the keys to enter the characters.

④

The previous screen returns.

⑤ **Keys**

Switches the on screen keyboard layout.

⑥ **Sym., Others, 0-9**

You can enter other characters of alphabet.

You can also enter text with marks such as [&] or [+] or numbers.

Touch to toggle the selection.

When you use any of "A", "Ä", "Å", "Æ", the displayed result is the same.

⑦ **OK**

Confirms the entry and allows you to proceed to the next step.

⑧

Deletes the input text one letter at a time, beginning at the end of the text. Continuing to touch the button deletes all of the text.

How to use the map

Most of the information provided by your navigation system can be seen on the map. You need to be come familiar with how information appears on the map.

How to read the map screen

This example shows an example of a 2D map screen.

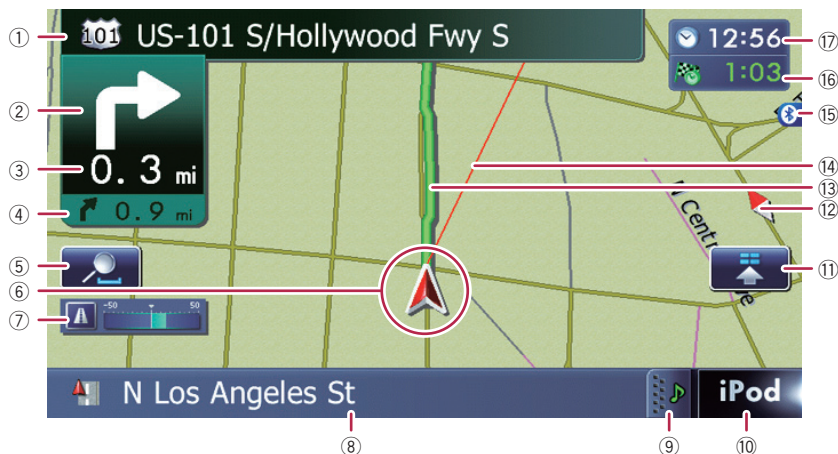

- Information with an asterisk (*) appears only when the route is set.
 - Depending on the conditions and settings, some items may not be displayed.
- ① **Name of the street to be used (or next guidance point)***
 - ② **Next direction of travel***
When you approach a guidance point, this item appears.
As you get closer to the guidance point, the color of the item changes to green.
 - Touching this item enables you to hear the next guidance again.
 - You can select between display and non display.
 - For details, refer to *Displaying maneuvers* on page 157.
 - ③ **Distance to the guidance point***
Shows the distance to the next guidance point.
 - Touching this item enables you to hear the next guidance again.
 - ④ **Second Maneuver Arrow***
Shows the turning direction after next and the distance to there.
 - For details, refer to *Displaying maneuvers* on page 157.
 - ⑤ **Zoom in/Zoom out**
Touching  displays touch panel keys for changing the map scale and the map orientation.
 - ⑥ **Current position**
Indicates the current location of your vehicle. The apex of the triangular mark indicates your orientation and the display moves automatically as you drive.
 - The apex of the triangular mark is the proper current position.
 - ⑦ **Eco-Meter**
Displays a graph comparing the past average fuel mileage and the average fuel mileage since the navigation system was last started.
 - For details, refer to *Displaying the fuel consumption information* on page 157.

How to use the map

⑧ Street name (or city name) that your vehicle is traveling along

➡ For details, refer to *Setting the current street name display* on page 156.

⑨ Extension tab for the AV information bar

Touching this tab opens the AV information bar and enables you to briefly view the current status on the AV source. Touching it again retracts the bar.

⑩ Shortcut to the AV operation screen

The AV source currently selected is shown. Touching the indicator displays the AV operation screen of the current source directly.

☐ If you connect your iPod to this navigation system, the artwork for the album that is playing appears.

⑪ Quick Access icon

Displays the “Quick Access” menu.

➡ For details, refer to *Setting the “Quick Access” menu* on page 28.

⑫ Map orientation indicator

- When “North up” is selected,  is displayed.

- When “Heading up” is selected,  is displayed.

☐ The red arrow indicates north.

⑬ Current route*

The route currently set is highlighted in color on the map. If a waypoint is set on the route, the route after the next waypoint is highlighted in another color.

⑭ Direction line*

The direction towards your destination (next waypoint, or cursor) is indicated with a straight line.

⑮ Bluetooth connection icon

This icon shows whether the device featuring Bluetooth technology is connected or not. You can select between display and non display.

➡ For details, refer to *Displaying the Bluetooth connection icon* on page 156.

⑯ Multi-Info window

Each touch of [Multi Info window] changes the display information.

- **Distance to the destination (or distance to waypoint)***

- **Estimated time of arrival at your destination or waypoint***

The estimated time of arrival is an ideal value calculated based on the value set for “Average Speed” and the actual driving speed. The estimated time of arrival is only a reference value, and does not guarantee arrival at that time.

- **Travel time to your destination or waypoint***

⑰ Current time

Meaning of guidance flags



Destination

The checkered flag indicates your destination.



Waypoint

The blue flags indicate your waypoints.



Guidance point

The next guidance point (next turning point, etc.) is shown by a yellow flag.

Enlarged map of the intersection

When “Close Up View” in the “Map Settings” screen is “On”, an enlarged map of the intersection appears.

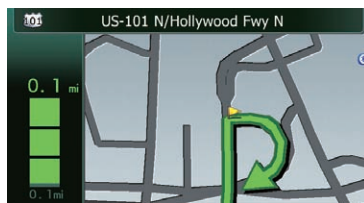

➡ For details, refer to *Setting the auto zoom display* on page 154.

How to use the map

Display during freeway driving

In certain locations of the freeway, lane information is available, indicating the recommended lane to be in to easily maneuver the next guidance.

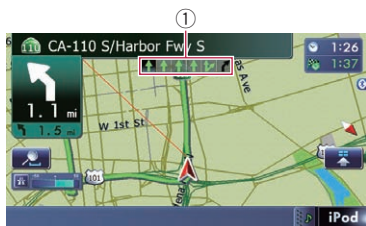

While driving on the freeway, freeway exit numbers and freeway signs may be displayed when in the vicinity of interchanges and exits.



① **Lane information**

② **Freeway exit information**

Displays the freeway exit.

③ **Freeway signs**

These show the road number and give directional information.

- ☐ If the data for these items is not contained in the built-in memory, the information is not available even if there are the signs on the actual road. ☐

Roads without turn-by-turn instructions

Routable roads (the route displayed and highlighted in purple) have only basic data and can only be used to plot a navigable route. Pioneer Navigation will only display a navigable route on the map (only the arrival guidance for the destination or a waypoint is available).

Please review and obey all local traffic rules along the highlighted route. (For your safety.) ☐

Operating the map screen

Changing the scale of the map

You can change the map scale between 25 yards and 1 000 miles (25 meters and 2 000 kilometers).

1 **Display the map screen.**

2 **Touch  on the map screen.**

 and  with the map scale appear.



3 **Touch  or  to change the map scale.**

- ☐ If you do not operate the function for a few seconds, the initial map screen automatically returns.
- Touch the direct scale key to change the map to the selected scale directly.

Switching the map orientation

You can switch how the map shows your vehicle's direction between "Heading up" and "North up".



- **Heading up:**
The map display always shows the vehicle's direction as proceeding toward the top of the screen.
- **North up:**
The map display always has north at the top of the screen.

How to use the map

- ❑ The map orientation is fixed at “North up” when the map scale is 25 miles (50 kilometers) or more.
- ❑ The map orientation is fixed at “Heading up” when the 3D map screen is displayed.

1 Display the map screen.

2 Touch on the map screen.

 or  appears.

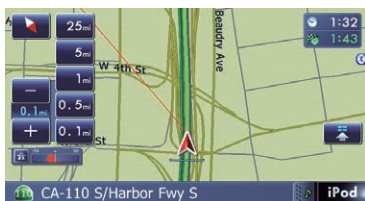

3 Touch or to switch the vehicle's direction.

Each time you touch the key changes that setting.

- ❑ If you do not operate the function for a few seconds, the initial map screen automatically returns.

Scrolling the map to the position you want to see

1 Display the map screen.

2 Touch and drag the map in the desired direction to scroll.



- ① Cursor
- ② Distance from the current position

Positioning the cursor to the desired location results in a brief informational overview about the location being displayed at the bottom of

screen, with street name and other information for this location being shown. (The information shown varies depending on the position.)

- ❑ The scrolling increment depends on your dragging length.
 - Touch .
- The map returns to the current position.
- ❑ Pressing **MODE** button returns the map to the current position.

Setting the “Quick Access” menu

“Quick Access” menu allows you to perform various tasks, such as route calculation for the location indicated by the cursor or registering a location in [Favorites], faster than using the navigation menu.

You can customize “Quick Access” displayed on screen. The “Quick Access” described here are prepared as the default setting.

- ➔ For details, refer to *Selecting the “Quick Access” menu* on page 160.
- ❑ Items marked with an asterisk (*) cannot be removed from the **Quick Access** menu.

● When the map is displayed, touch .

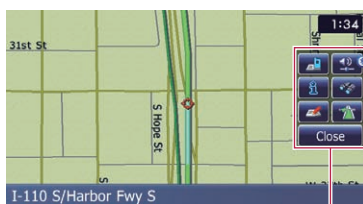

Quick Access menu

: **Route Options***

Displayed when the map is not scrolled. This item can be selected only during route guidance.

You can modify the conditions for route calculation and recalculate the current route.

- ➔ For details, refer to *Modifying the route calculation conditions* on page 42.

: **Destination***

How to use the map

Displayed when the map is scrolled. Set the route to the place specified with the cursor.

Registration

Register information on the location indicated by the cursor to **“Favorites”**.

- ➔ For details, refer to *Registering a location by scroll mode* on page 46.

Vicinity Search

Find POIs (Points Of Interest) in the vicinity of the cursor.

- ➔ For details, refer to *Searching for a nearby POI* on page 37.

Overlay POI

Displays icons for surrounding facilities (POI) on the map.

- ➔ For details, refer to *Displaying POI on the map* on page 157.

Volume

Displays the **“Volume Settings”** screen.

- ➔ For details, refer to *Setting the Volume for Guidance and Phone* on page 163.

Contacts

Displays the **“Contacts List”** screen.

- ➔ For details, refer to *Calling a number in the “Contacts List”* on page 69.

Close

Hides the **Quick Access** menu. 

Switching the view mode

Various types of screen displays can be selected for navigation guidance.

1 Display the “Map Settings” screen.

- ➔ For details, refer to *Displaying the “Map Settings” screen* on page 154.

2 Touch [View Mode].

The **“View Mode”** screen appears.

3 Touch the type that you want to set.

You can select the following types:

- **2D View** (default):
Displays a normal map (2D map).



- **3D View:**

Displays a map with an antenna view (3D map).



- **Street View:**

Information on the next four guidance points closest to the current location appear in order from top to bottom on the left side of the screen. The following information is displayed.

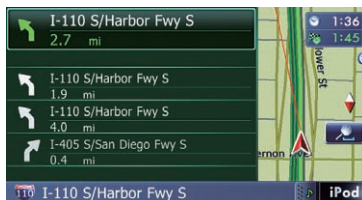

Name of the next route to be taken by the vehicle

Arrow indicating the direction of the vehicle

Distance to the guidance points

- This mode is available when the route is set.

- **Rear View:**

Displays the rear view image on the left side of the screen and the map on the right side of the screen.

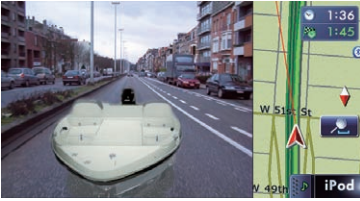

- This mode is available when [Camera] is set to "On".
 - ➔ For details, refer to *Setting for rear view camera* on page 164.

- **Eco Graph:**

Displays a graph for eco driving on the left side of the screen and the map on the right side of the screen.

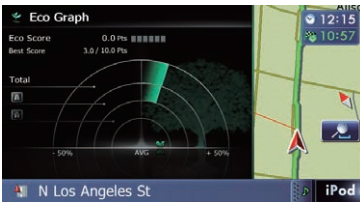

- ➔ For details, refer to *Displaying "Eco Graph"* on the next page. □

Eco-driving function

This navigation system is equipped with an Eco driving function that can be used to estimate whether you are driving in an environmentally friendly way.

This chapter describes this function.

- The fuel mileage calculated is based on a theoretical value determined from vehicle speed and position information from the navigation system. The fuel mileage displayed is only a reference value, and does not guarantee the mileage displayed can be obtained.
- The Eco driving functions are an estimate of the real time fuel consumption to average fuel consumption ratio and is not an actual value.
- The Eco driving functions and calculations take into consideration the location of the GPS position and speed of the vehicle in determining a value.

Displaying “Eco Graph”

This function estimates approximate fuel mileage based on your driving, compares that with your average fuel mileage in the past, and displays the results in a graph.

The graph appears when the map display is set to “Eco Graph”.

1 Display the “Map Settings” screen.

- For details, refer to *Displaying the “Map Settings” screen* on page 154.

2 Touch [View Mode].

The “View Mode” screen appears.

3 Touch [Eco Graph].

The “Eco Graph” screen appears.



① Eco Score

The result of the comparison of your past average fuel mileage and current average fuel mileage appears as a value from **0.0 Pts** (points) to **10.0 Pts**. The higher the value, the better the fuel mileage when compared to past route guidance. The green gauge indicates the current score, and the gray gauge indicates the best score to date.

The “Eco Score” is updated every 5 minutes.

- ❑ This is not displayed when “Eco Score” is set to “Off” or when no route is set.
- For details of the operation, refer to *Changing the eco function setting* on page 153.

② Best Score

Displays the best score to date.

- ❑ This is not displayed when “Eco Score” is set to “Off” or when no route is set.
- For details of the operation, refer to *Changing the eco function setting* on page 153.

③ Average fuel mileage comparison graph

Displays a comparison of the average fuel mileage up to the point the navigation system was last stopped (past average fuel mileage) and the current average fuel mileage. The display is updated every 3 seconds. The more the value moves in the direction of +, the better the fuel mileage. There are three different graph bars.

• Total

A comparison of the past average fuel mileage and the average fuel mileage from the location the navigation system was last started to the current driving location.

- **A**: **Ordinary Road**



A comparison of the past average fuel mileage and the average fuel mileage for 90 seconds in the past, while the vehicle is driving on an ordinary road.

- **B**: **Freeway**

A comparison of the past average fuel mileage and the average fuel mileage for 90 seconds in the past, while the vehicle is driving on a freeway.

④ Animal icons

The number of displayed animal icons increases or decreases according to the value of "Eco Score".

- This is not displayed when "Eco Score" is set to "Off" or when no route is set.
- If you try to use the "Eco Graph" function immediately after you start using the navigation system for the first time,  may be displayed and the function may not be available.
 - ➔ For details, refer to *Troubleshooting* on page 189.
- The display settings can be changed.
 - ➔ For details, refer to *Changing the eco function setting* on page 153. 

Displaying Eco Drive Level guidance

This navigation system is equipped with the "Eco Drive Level" function that estimates how well you have driven in an environmentally friendly way.

The points of "Eco Drive Level" change according to "Eco Score" when the vehicle reaches the destination. When a certain number of points is reached, the level increases and a message appears.

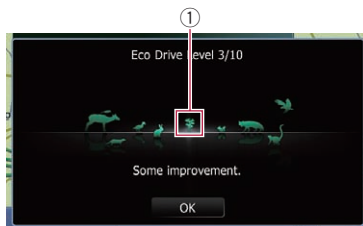

① Tree icon

As the level increases, a tree icon changes from a young tree to a big tree.

- This is not displayed when "Eco Drive Level" is set to "Off".
 - ➔ For details of the operation, refer to *Changing the eco function setting* on page 153. 

Sudden start alert

If the speed of the vehicle exceeds 25.5 mph (41 kmph) within 5 seconds from the time it is started, a message appears and a warning sound beeps.

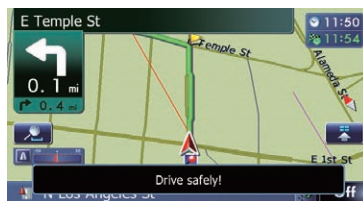

- ➔ For details of the operation, refer to *Changing the eco function setting* on page 153. 

Searching for and selecting a location

CAUTION

For safety reasons, these route setting functions are not available while your vehicle is in motion. To enable these functions, you must stop in a safe place and put on the parking brake before setting your route.

- Some information regarding traffic regulations depends on the time when the route calculation is performed. Thus, the information may not correspond with a certain traffic regulation when your vehicle actually passes through the location in question. Also, the information on the traffic regulations provided will be for a passenger vehicle, and not for a truck or other delivery vehicles. Always follow the actual traffic regulations when driving.

The basic flow of creating your route

- 1 Park your vehicle in a safe place and apply the parking brake.

↓
- 2 Display the "**Destination Menu**" screen.
 - For details of the operations, refer to *Screen switching overview* on page 22.

↓
- 3 Select the method of searching for your destination.

↓
- 4 Enter the information about your destination to calculate route.

↓
- 5 Confirm the location on the map.
 - For details, refer to *Setting a route to your destination* on page 41.

↓
- 6 The navigation system calculates the route to your destination, and then shows the route on the map.

↓
- 7 Check and decide the route.
 - For details, refer to *Setting a route to your destination* on page 41.

↓
- 8 Your navigation system sets the route to your destination, and the map of your surroundings appears.

↓
- 9 After releasing the parking brake, drive in accordance with navigation guidance.



Searching for a location by address

The most frequently used function is “**Address**”, in which the address is specified and the destination is searched.

You can select the method of searching for a location by address.

- Searching for a city name first
- Finding the location by specifying the house number

Searching for a city name first

- Depending on the search results, some steps may be skipped.

1 Display the “Destination Menu” screen.

- ➔ For details of the operations, refer to *Screen switching overview* on page 22.

2 Touch [Address].

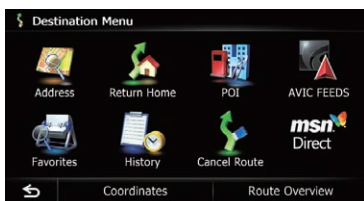

3 Touch the key next to “Country” to select the country.

If the destination is in another country, change the country setting.

- Once the country has been selected, you only have to change countries when your destination is outside of the country you selected.

4 Touch the key next to “State” and touch the desired state, province, or territory on the list.

If the location that you want to search for is in another state, province, or territory, this changes the area setting.

- Once the state, province, or territory has been selected, you only have to change

states, provinces, or territories when your destination is outside of the state, province, or territory you selected.

5 Touch [City].



6 Enter the city name and then touch [OK].

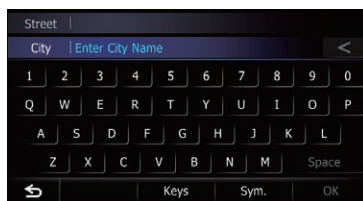

The “**Select City**” screen appears.

7 Touch the desired city name.

The “**Street Name**” screen appears.

- Touch .

The representative location of the city appears on the map screen.

8 Enter the street name and then touch [OK].

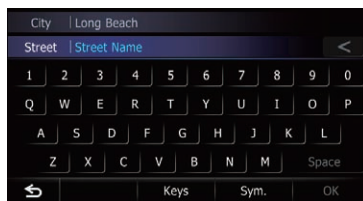

The “**Street Selection**” screen appears.

9 Touch the street you want.

Searching for and selecting a location

10 Enter the house number and then touch [OK].

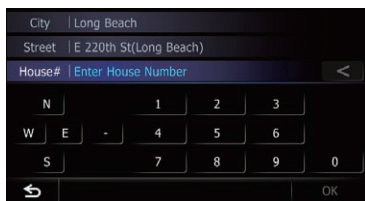

The “**House Number Selection**” screen appears.

11 Touch the desired house number range.

The searched location appears on the map screen.

➔ For the subsequent operations, refer to *Setting a route to your destination* on page 41.

Finding the location by specifying the house number

☐ Depending on the search results, some steps may be skipped.

1 Display the “**Address Search**” screen.

2 Touch [House #].

The “**Enter House Number**” screen appears.

3 Enter the house number and then touch [OK].

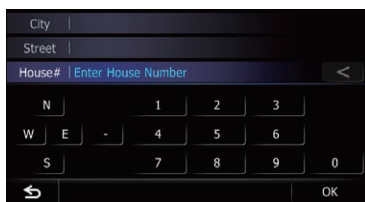

The “**Enter Street Name**” screen appears.

4 Enter the street name and then touch [OK].

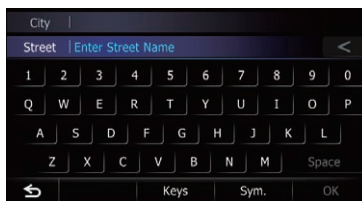

The “**Street Selection**” screen appears.

5 Touch the street you want.

The “**Enter City Name**” screen appears.

6 Enter the city name and then touch [OK].

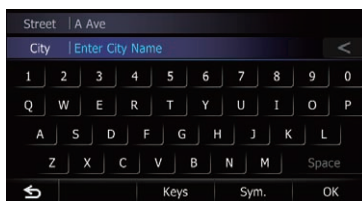

The “**Select City**” screen appears.

7 Touch the desired city name.

The “**House Number Selection**” screen appears.

If the house number you have entered is not found, a message appears. In that case, all house number ranges are listed after touching [Yes].

▪ Touch .

The representative location of the city appears on the map screen.

8 Touch the desired house number range.

The searched location appears on the map screen.

➔ For the subsequent operations, refer to *Setting a route to your destination* on page 41.

Searching for a name by entering multiple keywords

You can search for a name (such as a city name or a street name) by entering multiple keywords.

- ❑ The maximum character number that can be input is 18, and you can enter keywords up to 3.
 - ❑ Separate keywords by a space, quotation mark, comma, hyphen, period, or slash.
- The result of search depends on the number of entered keywords.

Entering a keyword

All names containing the word beginning with the entered keyword are displayed as a search result.

Entering two keywords

The names including the following words below are displayed as a result:

- First keyword you entered.
- The word beginning with the second key word.

Entering three keywords

The names including the following words below are displayed as a result:

- The words that completely match with both first and second keywords you entered.
- The word beginning with the third keyword, e.g. Searching "**East West Street**".

Entered key-words	Search results
EAST W	"East West Street" is searchable.
WEST S	
EAST WEST S	
WEST STREET E	
W E S	"East West Street" is not searchable.
E WEST STREET	



Setting up a route to your home

If your home location is stored, the route to your home can be calculated by touching a single key.

1 Display the "Destination Menu" screen.

- For details of the operations, refer to *Screen switching overview* on page 22.

2 Touch [Return Home].

- ❑ If you have not registered your home number, a message appears. Touch [Register] to start registration.
- For details, refer to *Registering your home* on page 152.

Searching for Points of Interest (POI)

Information about various facilities (Points Of Interest - POI), such as gas stations, parking lots or restaurants, is available. You can search for a POI by selecting the category (or entering the POI Name).

Searching for POIs by preset categories

You can search for POIs with a single touch from the preset category.

1 Display the "Destination Menu" screen.

- For details of the operations, refer to *Screen switching overview* on page 22.

2 Touch [POI].

Searching for and selecting a location

3 Touch the desired category.



The “POI List” screen appears.

4 Touch the POI you want.

The searched location appears on the map screen.

- ➔ For the subsequent operations, refer to *Setting a route to your destination* on page 41.

Searching for a POI directly from the name of the facilities

1 Display the “Destination Menu” screen.

- ➔ For details of the operations, refer to *Screen switching overview* on page 22.

2 Touch [POI].

The “POI Search” screen appears.

3 Touch [Spell Name].

4 Touch the state code key and touch the desired state, province, or territory on the list.

State code key

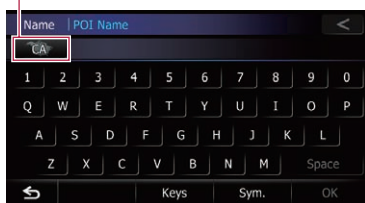

If the destination is in another country, touch [Country] to change the country setting when the “State/Province Selection” screen is displayed.

- ❑ Once the state, province, or territory has been selected, you only have to change them when your destination is outside of the country you selected.

5 Enter the POI name and then touch [OK].

The “POI List” screen appears.

6 Touch the POI you want.

The searched location appears on the map screen.

- Touch [Sort].
- Each time you touch [Sort] changes the sort order.
- ❑ Current order is indicated on the upper right of the screen.
 - : Sorts the items in the list in order by distance from the vehicle position.
 - : Sorts the items in the list alphabetically.
- ➔ For the subsequent operations, refer to *Setting a route to your destination* on page 41.

Searching for a nearby POI

You can search for POIs in your surroundings.

1 Display the “Destination Menu” screen.

- ➔ For details of the operations, refer to *Screen switching overview* on page 22.

2 Touch [POI].

The “POI Search” screen appears.

3 Touch [Near Me].

POIs are divided into several categories.

4 Touch the category you want.

The “POI List” screen appears.

- ❑ If there are more detailed categories within the selected category, repeat this step as many times as necessary.

5 Touch the POI you want.

The searched location appears on the map screen.

- ➔ For the subsequent operations, refer to *Setting a route to your destination* on page 41.

Searching for POIs around the destination

- ❑ This function is available when the route is set.

1 Display the “Destination Menu” screen.

- ➔ For details of the operations, refer to *Screen switching overview* on page 22.

2 Touch [POI].

The “POI Search” screen appears.

3 Touch [Near Destination].

POIs are divided into several categories.

4 Touch the category you want.

The “POI List” screen appears.

- ❑ If there are more detailed categories within the selected category, repeat this step as many times as necessary.

5 Touch the POI you want.

The searched location appears on the map screen.

- ➔ For the subsequent operations, refer to *Setting a route to your destination* on page 41.

Searching for POIs around the city

You can search for POIs around a specified city.

1 Display the “Destination Menu” screen.

- ➔ For details of the operations, refer to *Screen switching overview* on page 22.

2 Touch [POI].

The “POI Search” screen appears.

3 Touch [Around City].

4 Touch the state code key and touch the desired state, province, or territory on the list.

State code key



If the destination is in another country, touch [Country] to change the country setting when the “State/Province Selection” screen is displayed.

- ❑ Once the state, province, or territory has been selected, you only have to change them when your destination is outside of the country you selected.
- ➔ For details, refer to *Searching for a city name first* on page 34.

5 Enter the city name and then touch [OK].

The “Select City” screen appears.

6 Touch the desired city name.

The “POI List” screen appears.

- Touch .

The representative location of the city appears on the map screen.

7 Touch the category you want.

POIs are divided into several categories.

8 Touch the POI you want.

The searched location appears on the map screen.

- ➔ For the subsequent operations, refer to *Setting a route to your destination* on page 41. ❑

Searching for and selecting a location

Selecting destination from “Favorites”

Storing locations you visit frequently saves time and effort.

Selecting an item from the list provides an easy way to specify the position.

❑ This function is not available if no locations have been registered in “Favorites”.

➔ For details, refer to *Storing a location in “Favorites”* on page 46.

1 Display the “Destination Menu” screen.

➔ For details of the operations, refer to *Screen switching overview* on page 22.

2 Touch [Favorites].

3 Touch the entry you want.



The searched location appears on the map screen.

➔ For the subsequent operations, refer to *Setting a route to your destination* on page 41. □

Searching for POIs by using the data on the SD memory card

Creating a customized POI is possible by using the utility program AVIC FEEDS which is available separately, on your PC. (AVIC FEEDS will be available on our website.) Storing the customized POI properly and inserting the SD memory card enables the system to use the data for searches.

1 Insert an SD memory card into the SD card slot.

➔ For details of the operation, refer to *Inserting and ejecting an SD memory card* on page 15.

2 Display the “Destination Menu” screen.

➔ For details of the operations, refer to *Screen switching overview* on page 22.

3 Touch [AVIC FEEDS].

The “Select POI” screen appears.

4 Touch the item you want.

5 Touch the POI you want.

The searched location appears on the map screen.

➔ For the subsequent operations, refer to *Setting a route to your destination* on page 41. □

Selecting a location you searched for recently

The places that you have set as destination or waypoint in the past are automatically stored in “History”.

❑ If no location is stored in Destination History, you cannot select [History]. (If you perform a route calculation, you can select [History].)

❑ “History” can store up to 100 locations. If the entries reach the maximum, the new entry overwrites the oldest one.

1 Display the “Destination Menu” screen.

➔ For details of the operations, refer to *Screen switching overview* on page 22.

2 Touch [History].

3 Touch the entry you want.



The searched location appears on the map screen.

- For the subsequent operations, refer to *Setting a route to your destination* on the next page.

Searching for a location by coordinates

Entering a latitude and longitude pinpoints the location.

1 Display the “Destination Menu” screen.

- For details of the operations, refer to *Screen switching overview* on page 22.

2 Touch [Coordinates].

3 Touch [East] or [West], and then enter the longitude.

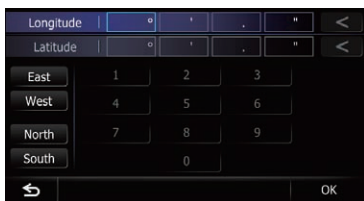

To enter W 50°1'2.5" for example, touch **[West]**, [0], [5], [0], [0], [1], [0], [2], and [5].

4 Touch [North] or [South], and then enter the latitude.

To enter N 5°1'2.5" for example, touch **[North]**, [0], [5], [0], [1], [0], [2], and [5].

5 Touch [OK].

The searched location appears on the map screen.

- For the subsequent operations, refer to *Setting a route to your destination* on the next page.

After the location is decided

Setting a route to your destination

1 Search for a location.

- For details, refer to Chapter 6.

After searching for the destination, the Location confirmation screen appears.

2 Touch [OK].

Location confirmation screen

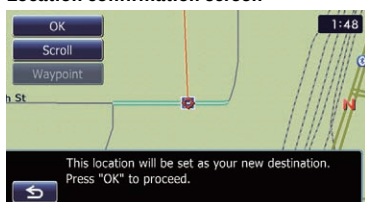

The destination is set, and then route calculation starts.

When the route calculation is completed, Route confirmation screen appears.

- If you press the **MODE** button during route calculation, the calculation is canceled and the map screen appears.

▪ Touch [Scroll].

The map display changes to the scroll mode. You can fine tune the location in the scroll mode, and then you can set the location as your destination or do various operations.

▪ Touch [Waypoint].

The location is added to the **"Waypoints List"** screen.

- If a destination is not set, [Waypoint] is not available.

3 Touch [OK].

Route confirmation screen

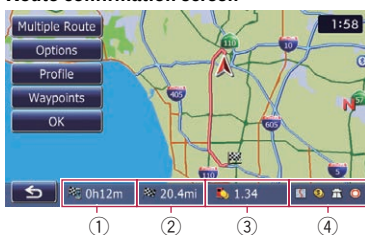

Sets the displayed route as your route, and starts the route guidance.

- ① Travel time to your destination
- ② Distance to the destination
- ③ Estimated fuel cost to your destination
 - For details, refer to *Inputting the fuel consumption information for calculating the fuel cost* on page 150.
- ④ Route calculation condition
 - Touch .

The message confirming whether to cancel the calculated route appears.

Touch **[Yes]** to cancel the calculated route, and then the map screen appears.



① Multiple Route

- For details, refer to *Displaying multiple routes* on this page.

② Options

- For details, refer to *Modifying the route calculation conditions* on the next page.

③ Profile

- For details, refer to *Checking the current itinerary* on page 43.

④ Waypoints

- For details, refer to *Editing waypoints* on page 44.

Displaying multiple routes

You can select a desired route from multiple route options. Calculated routes are shown in different colors.

- If you set waypoints, you cannot display multiple routes.

1 Touch [Multiple Route] on the Route confirmation screen.

Multiple route options appear.

2 Touch 1 to 6.

Another route is displayed.

3 Touch [OK].

Route confirmation screen appears.

Displaying the “Route Overview” screen

- 1 Press the HOME button to display the “Top Menu” screen.
- 2 Touch [Destination].
The “Destination Menu” screen appears.
- 3 Touch [Route Overview].

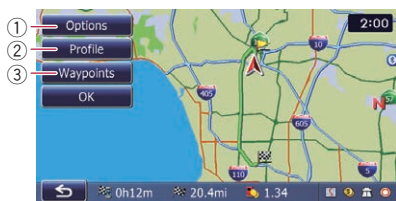
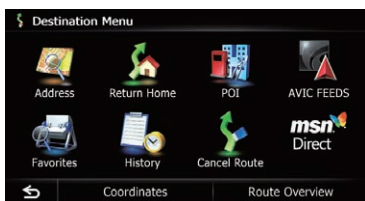

- ① **Options**
 - ➔ For details, refer to *Modifying the route calculation conditions* on this page.
 - ② **Profile**
 - ➔ For details, refer to *Checking the current itinerary* on the next page.
 - ③ **Waypoints**
 - ➔ For details, refer to *Editing waypoints* on page 44.
 - ☐ [Route Overview] is active only when the route is set.
- 4 Touch [OK]. ☐

Modifying the route calculation conditions

You can modify the conditions for route calculation and recalculate the current route.

- 1 Display the “Route Overview” screen.
 - ➔ For details, refer to *Displaying the “Route Overview” screen* on this page.
- 2 Touch [Options].
- 3 Touch the desired items to change the route calculation conditions and then touch [OK].



The route is recalculated, and the Route confirmation screen appears.

Items that users can operate

Settings marked with an asterisk (*) show that these are default or factory settings.

Route Condition

This setting controls how the route should be calculated by taking into account the time, distance or main road.

Determines which condition takes priority for route calculation.

Fast*:

Calculates a route with the shortest travel time to your destination as a priority.

Short:

Calculates a route with the shortest distance to your destination as a priority.

Main Road:

Calculates a route that passes major arterial road as a priority.

Checking and modifying the current route

Avoid Toll Road

This setting controls whether toll roads (including toll areas) should be taken into account.

Off*:

Calculates a route that may include toll roads (including toll areas).

On:

Calculates a route that avoids toll roads (including toll areas).

- The system may calculate a route that includes toll roads even if “On” is selected.

Avoid Ferry

This setting controls whether ferry crossings should be taken into account.

Off*:

Calculates a route that may include ferries.

On:

Calculates a route that avoids ferries.

- The system may calculate a route that includes ferries even if “On” is selected.

Avoid Freeway

This setting controls whether freeways may be included in the route calculation.

Off*:

Calculates a route that may include freeways.

On:

Calculates a route that avoids freeways.

- The system may calculate a route that includes freeways even if “On” is selected.

Time restrictions

This setting controls whether streets or bridges that have traffic restrictions during a certain time should be taken into account.

- If you want to set your route to avoid raised draw bridges, select “On”.

On*:

Calculates a route while avoiding streets or bridges with traffic restrictions during a certain time.

Off:

Calculates a route while ignoring traffic restrictions.

- The system may calculate a route that includes streets or bridges that are subject to traffic restrictions during a certain time even if “On” is selected.

CAUTION

If the time difference is not set correctly, the navigation system cannot consider traffic regulations correctly. Set the time difference correctly (➔). Refer to *Setting the time difference* on page 162).

Learning Route

The system learns the travel history of your vehicle for each road.

This setting controls whether or not the travel history should be taken into account.

On*:

Calculates a route with the travel history taken into account.

Off:

Calculates a route without the travel history taken into account.

Clear:

Clears the current travel history.

Checking the current itinerary

You can check the route details.

1 Display the “Route Overview” screen.

- ➔ For details, refer to *Displaying the “Route Overview” screen* on the previous page.

2 Touch [Profile].

The “Route Profile” screen appears.

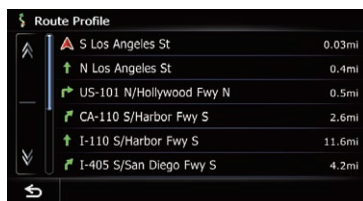

Editing waypoints

You can edit waypoints (locations you want to visit on the way to your destination) and recalculate the route so that it passes through these locations.

Adding a waypoint

Up to 5 waypoints can be set, and waypoints and final destination can be sorted automatically or manually.

1 Display the “Route Overview” screen.

- ➔ For details, refer to *Displaying the “Route Overview”* screen on page 42.

2 Touch [Waypoints].

The “Waypoints List” screen appears.

3 Touch [Add].



The “Select Search method” screen appears.

4 Search for a location.

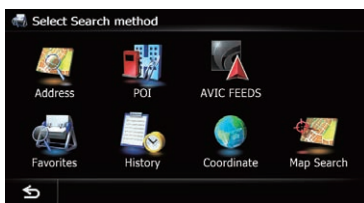

- ➔ For details, refer to Chapter 6.

5 Touch [OK].



6 Touch [OK] on the “Waypoints List” screen.



The route is recalculated, and the Route confirmation screen appears.

- If you set waypoints, you cannot display multiple routes.

Deleting a waypoint

You can delete waypoints from the route and then recalculate the route. (You can delete successive waypoints.)

1 Display the “Route Overview” screen.

- ➔ For details, refer to *Displaying the “Route Overview”* screen on page 42.

2 Touch [Waypoints].

The “Waypoints List” screen appears.

3 Touch [Delete] next to the waypoint that you want to delete.

The touched waypoint will be deleted from the list.

4 Touch [OK] on the “Waypoints List” screen.

The route is recalculated, and the Route confirmation screen appears.

5 Touch [OK].

The map of the current position appears.

Checking and modifying the current route

Sorting waypoints

You can sort waypoints and recalculate the route.

- ❑ You cannot sort waypoints that you have already passed.

1 Display the “Route Overview” screen.

- For details, refer to *Displaying the “Route Overview” screen* on page 42.

2 Touch [Waypoints].

The “Waypoints List” screen appears.

3 Touch [Sort].

The “Sort Waypoints” screen appears.

4 Touch the waypoint or destination.



Put them in the desired order.

- Touch [Automatic].

You can sort the destination and waypoints automatically. The system will show the nearest waypoint (distance in a straight line) from the current location as waypoint 1, and sort the other points (including your destination) in order of distance from the waypoint 1.

- Touch [Clear].

Waypoint sort is canceled.

5 Touch [OK].

The “Waypoints List” screen appears.

6 Touch [OK] on the “Waypoints List” screen.

The route is recalculated, and the Route confirmation screen appears.

7 Touch [OK].

The map of the current position appears. ◻

Canceling the route guidance

If you no longer need to travel to your destination, follow the steps below to cancel the route guidance.

1 Display the “Destination Menu” screen.

- For details of the operations, refer to *Screen switching overview* on page 22.

2 Touch [Cancel Route].

A message confirming the cancellation of the current route appears.

3 Touch [Yes].

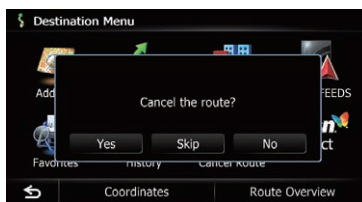

The current route is deleted, and a map of your surroundings reappears.

- Touch [Skip].

The next waypoint along the route is skipped. A new route to your destination through all remaining waypoints, except for the skipped waypoint, is calculated.

When the route calculation is completed, Route confirmation screen appears.

- ❑ [Skip] is available only when a waypoint is set.

- Touch [No].

The previous screen returns without deleting the route. ◻

Storing a location in “Favorites”

Storing your favorite locations as “Favorites” provides you with the opportunity to save the time and effort of re entering this information. Stored items can be made available on “Favorites” later.

Registering a location by “Favorites”

Favorites can store up to 400 registered locations. These can include your home location, favorite places, and destinations you have already registered.

- “Favorites” can store up to 400 locations.
- Home location is counted as one of the items in “Favorites”.

1 Display the “Destination Menu” screen.

- For details of the operations, refer to *Screen switching overview* on page 22.

2 Touch [Favorites].

The “Favorites” screen appears.

3 Touch [Add].

The “Select Search method” screen appears.

4 Search for a location.

- For details about the search methods, refer to Chapter 6.

5 When the map of the location you want to register is displayed, touch [OK].

The location is registered, and then the “Edit Favorite” screen appears.

- For details, refer to *Editing the entry in the “Favorites” list* on this page.

6 Touch [OK].

The registration is completed.

Registering a location by scroll mode

1 Touch and drag the screen to scroll the map to the position that you want to register.

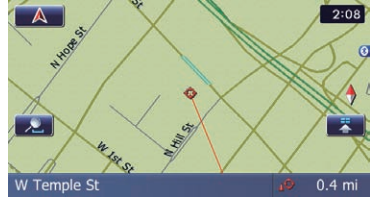

2 Touch  to display the Quick Access menu.

3 Touch .

The location is registered, and then the “Edit Favorite” screen appears.

- For details, refer to *Editing the entry in the “Favorites” list* on this page.

4 Touch [OK].

The registration is completed. .

Editing registered locations

Editing the entry in the “Favorites” list

1 Display the “Destination Menu” screen.

- For details of the operations, refer to *Screen switching overview* on page 22.

2 Touch [Favorites].

The “Favorites” screen appears.

3 Touch  next to the location that you want to edit.

The “Edit Favorite” screen appears.

Registering and editing locations

- 4 Touch the item that you want to change the setting.

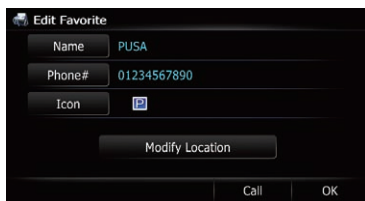

- Up to 17 characters can be input for the name.

- Touch **[Name]**.

You can enter the desired name.

- Touch **[Phone#]**.

You can edit the registered phone number. To dial the number, touch **[Call]**.

The maximum digits you can enter for the phone number is 15.

- Touch **[Icon]**.

You can change the symbol displayed on the map and "Favorites".

- Touch **[Modify Location]**.

You can change the registered location by scrolling the map.

- 5 Touch **[OK]**.

The registration is completed.

Editing your home

When you have already registered your home, you can edit the information of your home.

- 1 Display the "Destination Menu" screen.

- For details of the operations, refer to *Screen switching overview* on page 22.

- 2 Touch **[Favorites]**.

- Home location is displayed on the top of the list.

- 3 Touch  next to the home location.



The "Edit Favorite" screen appears.

- 4 Touch the item that you want to change the setting.

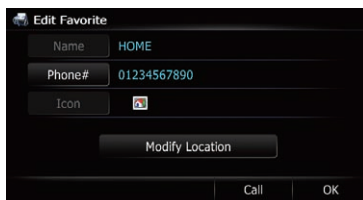

- Touch **[Phone#]**.

To dial the number, touch **[Call]**.

- Touch **[Modify Location]**.

You can change the registered location by scrolling the map.

- For home information, **[Name]** and **[Icon]** are not editable.

- 5 Touch **[OK]**.

The registration is completed.

Sorting the entry in the "Favorites" list

- 1 Display the "Destination Menu" screen.

- For details of the operations, refer to *Screen switching overview* on page 22.

- 2 Touch **[Favorites]**.

The "Favorites" screen appears.

- 3 Touch **[Sort]**.

Each time you touch **[Sort]** changes the sort order.

- Current order is indicated on the upper right of the screen.

-  :

Sorts the items in the list in order by distance from the vehicle position.

- **ABC** ↓: Sorts the items in the list alphabetically.
- **📄** ↓: Sorts the items in the list in order of the recently used items.

Deleting the entry from the “Favorites” list

1 Display the “Destination Menu” screen.

- ➔ For details of the operations, refer to *Screen switching overview* on page 22.

2 Touch [Favorites].

The “Favorites” screen appears.

3 Touch [Delete].

4 Select the location you want to delete.



A check mark appears next to the selected location.

- Touch **[All]** or **[None]**.

Selects or deselects all entries.

5 Touch [Delete].



A message will appear asking you to confirm the deletion.

6 Touch [Yes].

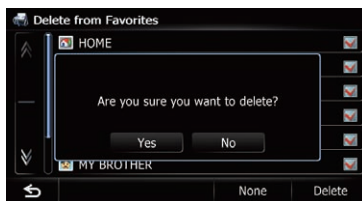

The data you selected is deleted.

- Touch **[No]**.

Cancels the deletion.

Exporting and importing “Favorites” items

Exporting “Favorites” items

Exporting the “Favorites” data to an SD memory card for editing is possible by using the utility program AVIC FEEDS which is available separately, on your PC.

- If there is previous data in the SD memory card, the data is overwritten with new data when current data is exported.

1 Insert an SD memory card into the SD card slot.

- ➔ For details of the operation, refer to *Inserting and ejecting an SD memory card* on page 15.

2 Display the “Destination Menu” screen.

- ➔ For details of the operations, refer to *Screen switching overview* on page 22.

3 Touch [Favorites].

The “Favorites” screen appears.

4 Touch **📄**.

Data export starts.

After the data is exported, the completion message appears.

Registering and editing locations



5 Touch [OK].

The "Favorites" screen appears.

Importing the "Favorites" items

You can import the locations that you have edited on the utility program AVIC FEEDS which is available separately to "Favorites".

- When a location that is already registered in "Favorites" is imported, the location is overwritten.

1 Store the item into the SD memory card by using the AVIC FEEDS.

2 Insert an SD memory card into the SD card slot.

- For details of the operation, refer to *Inserting and ejecting an SD memory card* on page 15.

3 Display the "Destination Menu" screen.

- For details of the operations, refer to *Screen switching overview* on page 22.

4 Touch [Favorites].

The "Favorites" screen appears.

5 Touch [Import].

The message confirming whether to replace the stored items appears.

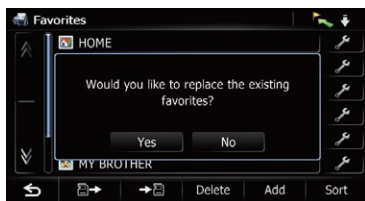

6 Touch [Yes].

Data import starts.

After importing the data is finished, the "Favorites" screen appears.

Deleting the entry from the "History" list

Items in "History" can be deleted. All entries in "History" can be deleted at once.

1 Display the "Destination Menu" screen.

- For details of the operations, refer to *Screen switching overview* on page 22.

2 Touch [History].

The "Destination History List" screen appears.

3 Touch [Delete].

The "Delete from History" screen appears.

4 Select the location you want to delete.



A check mark appears next to the selected location.

- Touch [All] or [None].
Selects or deselects all entries.

5 Touch [Delete].



A message will appear asking you to confirm the deletion.

6 Touch [Yes].

The data you selected is deleted.

- Touch [No].
Cancels the deletion.

If you have an active subscription to MSN Direct service, you can check and browse various information on your navigation system, such as gas prices, movie times, weather conditions and traffic information. The information will be updated periodically.

IMPORTANT:

To receive MSN® Direct on an MSN Direct ready device, you must be within an MSN Direct coverage area; see <http://www.msndirect.com/pioneer> for current coverage maps. Coverage areas are affected by reception limitations of the FM network as well as other factors, which may affect the ability to receive FM broadcasts. Coverage areas are subject to change. Not all content is available in all coverage areas.

© 2008 Microsoft Corporation. All rights reserved. Microsoft, MSN, and the MSN logo are trademarks of the Microsoft group of companies.

Notice about MSN Direct

Pioneer is not responsible for the accuracy of the MSN Direct content. The MSN Direct content may not be current or available at times, and is subject to change without notice.

Activating the service

You have to activate MSN Direct first.

- A web connected computer is required for the online subscription.
- If you have difficulty in online subscription, please call toll free 1 866 658 7032.

General flow chart:

- 1 Check your product key.
You have to know your product key for the subscription.
(Refer to *Checking your product key* on this page.)

↓

- 2 Make an online subscription to MSN Direct service using your PC.
(Refer to *Subscribing to the MSN Direct service* on the next page.)

↓

- 3 Activate the MSN Direct service on this product.
(Refer to *Activating the MSN Direct function* on the next page.)

↓

- 4 Activation is complete.

Checking your product key

The product key that you can find here is used in the online subscription.

1 Touch [Destination] on the "Top Menu", and then touch [MSN Direct].

The "MSN Direct" screen appears.

2 Touch [Status].

3 Write your product key down in the following box:



Browsing information on MSN Direct

Subscribing to the MSN Direct service

Within two days of completing the subscription, execute *Activating the MSN Direct function*.

1 Access the following URL and read the description.

http://www.msndirect.com/pioneer

2 Be sure to check the coverage area and other availabilities of MSN Direct on the web page.

3 Go to the page for activation and enter your product key.

4 Follow the directions on the web page to complete the subscription.

Activating the MSN Direct function

After the online subscription, complete the activation so that the navigation system can receive the information.

This operation must be performed under the following conditions:

You are currently in the coverage area of MSN Direct.

The signal strength (📶) on the “MSN Direct Status” screen is not weak.

1 Boot-up your navigation system.

2 Display the “Destination Menu” screen.

➤ For details of the operations, refer to *Screen switching overview* on page 22.

3 Touch [MSN Direct].

The “MSN Direct” screen appears.

4 Touch [Status].

5 Wait until the activation status changes to “Active”.

It may take approximately 20 or 30 minutes to complete the activation.

After activation is complete, the information will be available on each menu. ◻

Browsing gas prices

Recent gas prices of nearby gas stations are displayed in a list.

Although the MSN Direct service regularly updates gas price information, the information provided may not necessarily correspond to actual gas prices. Please refer to *Notice about MSN Direct* on the previous page.

It may take up to 24 hours for all the data to be come available under the following conditions:

- When you use MSN Direct for the first time.
- When you have not performed this function previously around the current area.
- After the navigation system has been turned off for a few days.

1 Display the “Destination Menu” screen.

➤ For details of the operations, refer to *Screen switching overview* on page 22.

2 Touch [MSN Direct].

The “MSN Direct” screen appears.

3 Touch [Gas Prices].



The “Gas Prices” screen appears.

4 Touch the desired tab to change the sort order.

Name	Price	Dist.
Unknown	\$3.05 (Today)	8.1mi
Chevron	\$3.05 (Today)	8.5mi
76	\$3.06 (2days ago)	8.7mi
76	\$3.39 (2days ago)	8.8mi
Shell	\$3.03 (Today)	9.0mi

Available options:

- **Dist.** (default):
Sorts the items in the list in order by distance from the vehicle position.
- **Name:**
Sorts the items in the list alphabetically.
- **Price:**
Sorts the items in the list by price.

▪ Touch **[Refresh]**.

The information is updated.

- **[Refresh]** appears when new gas prices information is received.

5 Touch on the item that you want to view in detail.



- ① **Name:**
Indicates the names of gas stations.
□ If there is no data, "**Unknown**" is displayed.
- ② **Price:**
Red: indicates gas stations whose gas prices exceed average prices of all gas stations that are received.
Green: indicates gas stations whose gas prices go below average prices of all gas stations that are received.
White: indicates gas stations with average prices of all gas stations that are received. The information in () shows how current the information is.
□ If there is no data, "-----" is displayed.
- ③ **Dist.:**
Indicates the distance from the current location to the gas station.
□ Touching  allows you to check the location on a map.

6 Touch **[OK]**.



Location confirmation screen appears.

- ➔ For details, refer to *Setting a route to your destination* on page 41. □

Browsing movie times

Nearby theaters can be displayed on a list. Switching the screen allows you to see the movie title now showing.

Although the MSN Direct service regularly updates movie information, the information provided may not necessarily correspond to actual movie information. Please refer to *Notice about MSN Direct* on page 50.

It may take up to six hours for all the data to become available under the following conditions:

- When you use MSN Direct for the first time.
- When you have not performed this function previously around the current area.
- After the navigation system has been turned off for a few days.

Searching for a theater by selecting a movie title

1 Display the "Destination Menu" screen.

- ➔ For details of the operations, refer to *Screen switching overview* on page 22.

2 Touch **[MSN Direct]**.

The "**MSN Direct**" screen appears.

3 Touch **[Movie Times]**.

The "**All Movie Theaters**" screen appears.

Browsing information on MSN Direct

4 Touch [All Movie Titles].



The movie titles now showing are displayed.

- Touch **[Refresh]**.

The information is updated.

- [Refresh]** appears when the new information is received.

5 Touch the desired movie title.

The theaters that are currently showing the selected movie are displayed.



- Touch **[Refresh]**.

The information is updated.

- [Refresh]** appears when the new information is received.

6 Touch the desired tab to change the sort order.

Available options:

- **Dist.** (default):
Sorts the items in the list in order by distance from the vehicle position.
- **Name:**
Sorts the items in the list alphabetically.

7 Touch on the item that you want to view in detail.

- Touching  allows you to check the location on a map.

8 Touch [OK].

Location confirmation screen appears.

- For details, refer to *Setting a route to your destination* on page 41.

- Touch **[Call]**.

Enables you to call the position if a telephone number is available. (Pairing with cellular phone featuring Bluetooth wireless technology is required.)

Searching for a movie title by selecting a theater

1 Display the "Destination Menu" screen.

- For details of the operations, refer to *Screen switching overview* on page 22.

2 Touch [MSN Direct].

The "MSN Direct" screen appears.

3 Touch [Movie Times].

The "All Movie Theaters" screen appears.

4 Touch the desired tab to change the sort order.

Available options:

- **Dist.** (default):
Sorts the items in the list in order by distance from the vehicle position.
- **Name:**
Sorts the items in the list alphabetically.

5 Touch the desired theater.

The movie titles currently shown on the selected theater are displayed.

6 Touch on the item that you want to view in detail.

- Touching  allows you to check the location on a map.

- Touch **[Refresh]**.

The information is updated.

- [Refresh]** appears when the new information is received.

7 Touch [OK].

Location confirmation screen appears.

- For details, refer to *Setting a route to your destination* on page 41.

- Touch **[Call]**.

Enables you to call the position if a telephone number is available. (Pairing with cellular phone featuring Bluetooth wireless technology is required.)

Browsing weather information

Local weather information can be displayed on a list. Switching the screen allows you to see worldwide weather conditions.

Although the MSN Direct service regularly updates weather information, the information provided may not necessarily correspond to actual weather conditions. Please refer to *Notice about MSN Direct* on page 50.

Checking the local weather information

1 Display the "Destination Menu" screen.

- ➔ For details of the operations, refer to *Screen switching overview* on page 22.

2 Touch [MSN Direct].

The "MSN Direct" screen appears.

3 Touch [Weather].

The local weather information is displayed.



The city name, weather, temperature and wind direction are displayed in list format.

- If there is no information available, or "-----" is displayed.

4 Touch the desired area.

Detailed information is displayed.



▪ Touch [Forecast].

Displays the weather forecasts for these three days.

Checking worldwide weather conditions

1 Display the "Destination Menu" screen.

- ➔ For details of the operations, refer to *Screen switching overview* on page 22.

2 Touch [MSN Direct].

The "MSN Direct" screen appears.

3 Touch [Weather].

The local weather information is displayed.

4 Touch [Worldwide].

Worldwide weather conditions are displayed. The area names and weather conditions are displayed on the list. The list is sorted alphabetically by the area name.

5 Touch the desired area.

Detailed information is displayed.

How to read MSN Direct information on the map

MSN Direct icons can be displayed on the map.

- ➔ For details, refer to *Displaying the MSN Direct icons* on page 157.

MSN Direct icons are not displayed when the map scale is 0.75 mile (1 kilometer) or more.

Browsing information on MSN Direct



The following MSN Direct icons appear in the map screen.

- **Gas Prices**

: Indicates gas stations whose gas prices exceed average prices of all gas stations that are received.

: Indicates gas stations whose gas prices equal or go below average prices of all gas stations that are received.

: Indicates gas stations without any price information.

- **Movie Times**

: Indicates the locations of movie theaters.

- **Local Events**

: Indicates the locations of music events.

: Indicates the locations of performing arts events.

: Indicates the locations of visual arts events.

: Indicates the locations of spectator events.

: Indicates the locations of other events.

Using traffic information

You can view current traffic conditions and information. When the navigation system receives updated traffic information, it will overlay the traffic information on your map and also display detailed text information when available.

The navigation system takes into account traffic information and tries to avoid traffic congestion and suggests better routes. Also,

when you are traveling along a route and the system finds a better route to avoid traffic congestion.

The system acquires the traffic information up to 100 miles in radius from the vehicle position. (If there is a lot of traffic information around your vehicle, the radius will be shorter than 100 miles.)

The term “traffic congestion” in this section indicates the following types of traffic information: slow, queuing and stationary traffic and closed/blocked roads. This information is always taken into consideration when checking your route, and the information related with these events cannot be turned off. If you select other traffic information in “**Traffic Settings**”, the information can be displayed in a list or on a map.

➔ For details, refer to *Selecting traffic information to display* on page 59.

Checking all traffic information

Traffic information except traffic flow information is displayed onscreen in a list.

Although the MSN Direct service regularly updates traffic information, the information provided may not necessarily correspond to actual traffic conditions. Please refer to *Notice about MSN Direct* on page 50.

- 1 **Display the “Destination Menu” screen.**

➔ For details of the operations, refer to *Screen switching overview* on page 22.

- 2 **Touch [MSN Direct].**

The “**MSN Direct**” screen appears.

- 3 **Touch [Traffic Events].**

The “**Traffic Event List**” screen appears.

4 Select an incident you want to view in detail.

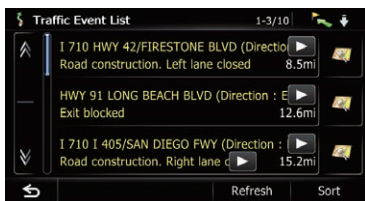

The details of the selected incident are displayed.

- Touching an incident you want to see allows you to view the detailed information of the incident. If the information cannot be displayed on one screen, touch or to view the remaining information.
- Touching allows you to check the location on a map. (Traffic information without positional information cannot be checked on a map.)
- Touch **[Sort]**.

You can sort the traffic information.

Each time you touch the key changes that setting.

- :
 - You can sort the traffic information by distance from your current position. For the list displayed when you touch **[Traffic Events]**, the list will be sorted according to the linear distance from the vehicle position to the traffic information. For the list displayed when you touch **[Traffic On Route]**, the list will be sorted according to the distance from the vehicle position to the traffic information.
- :
 - You can sort the traffic information in alphabetical order.
- :
 - You can sort the traffic information according to the incident. The list will be sorted in the order of closed/blocked roads, traffic congestion, accidents, road works and others.

Current order is indicated on the upper right of the screen.

- Touch **[Refresh]**.

When new traffic information is received, current information is changed or old information has been removed, the list is updated to reflect the new situation.

5 Touch .

The previous screen returns.

Checking traffic information on the route

All traffic information on the current route (including traffic flow information) is displayed onscreen in a list.

1 Display the “Destination Menu” screen.

- For details of the operations, refer to *Screen switching overview* on page 22.

2 Touch **[MSN Direct]**.

The “**MSN Direct**” screen appears.

3 Touch **[Traffic On Route]**.

The “**Traffic On Route**” screen appears.

The method for checking the content displayed on the screen is the same for *Checking all traffic information* on the previous page.

How to read traffic information on the map

The traffic event information displayed on the map is as follows.

- A line is displayed only when the map scale is 2.5 miles (5 km) or lower.
- Icon appears only when the scale on the map is 10 miles (20 km) or lower. If the scale is changed, the icons are resized according to the selected scale.

Browsing information on MSN Direct

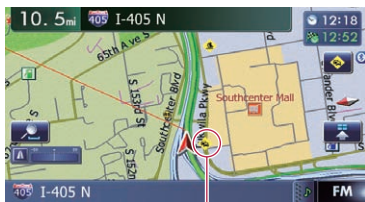

Traffic event icon

- with yellow line:
Stop and go traffic
 - with red line:
Stopped traffic
 - with black line:
Closed/blocked roads
 - etc.:
Accidents, constructions, etc.
- For meanings of other icons, check them the **"Traffic Type Settings"** screen.
- ➔ For details of the operations, refer to *Selecting traffic information to display* on page 59.

Viewing the traffic flow

All traffic flow information is displayed on screen in a list.

1 Display the "Destination Menu" screen.

- ➔ For details of the operations, refer to *Screen switching overview* on page 22.

2 Touch [MSN Direct].

The **"MSN Direct"** screen appears.

3 Touch [Traffic Flow].

A list with traffic flow information that has been received is shown. The list is sorted by distance from your current position. Places (street names) where incidents have occurred are displayed on the list.

4 Select an incident you want to view in detail.

The details of the selected incident are displayed.

- Touching an incident you want to see allows you to view the detailed information of the incident. If the information cannot be dis-

played on one screen, touch or to view the remaining information.

- Touching allows you to check the location on a map. (Traffic information without positional information cannot be checked on a map.)
- Touch **[Sort]**.

You can sort the traffic information.

Each time you touch the key changes that setting.

- :
You can sort the traffic information by the linear distance from your current position.
- :
You can sort the traffic information in alphabetical order.
- :
You can sort the traffic information by the average speed.
The list will be sorted in the order of closed/blocked roads, traffic congestion, accidents, road works and others.

Current order is indicated on the upper right of the screen.

- Touch **[Refresh]**.

When new traffic information is received, current information is changed or old information has been removed, the list is updated to reflect the new situation.

- Touch .

The traffic event information displayed on the map is as follows.

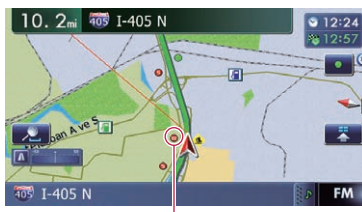

Traffic flow icon and line

- **Red:** average speed in this area is slower than 15 mph (24 km/h)
- **Yellow:** average speed in this area is between 15 mph to 45 mph (24 km/h to 72 km/h)

- **Green:** average speed in this area is faster than 45 mph (72 km/h) (An icon without a line will be displayed)

Setting an alternative route to avoid traffic congestion

The navigation system checks at regular intervals whether or not there is the traffic information on your route. If the navigation system detects any traffic congestion on your current route, the system tries to find a better route in the background.

- The following types of traffic incidents on the route will be checked: slow, back ups, stationary traffic, and closed/blocked roads except for closed freeway exits/entrances.

Checking for traffic congestion automatically

If there is information about traffic congestion on your current route and if an alternative route can be found, the navigation system will recommend a new alternative route automatically. In such a case, the following screen will appear.

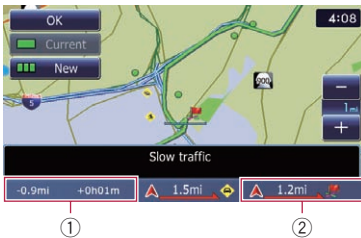

- ① Difference in distance and travel time between the existing route and new route.
 - ② Distance from the current position of your vehicle to the point of entry into the new route.
- There is no action if the system cannot find any traffic congestion information on your route or the system cannot find an alternative.

1 Touch [New].

The recommended route is displayed on the screen.

- Touch [Current].

The current route is displayed on the screen.

2 Touch [OK].

The displayed route is set.

- When no selection is made, the screen reverts to the previous screen.

Checking traffic information manually

Touching the notification icon on the map screen allows you to check traffic information on your route while the icon is displayed. The notification icon is only displayed on the navigation map screen if there is any traffic information on your route.

- The notification icon is not available if your vehicle deviates from the route.

1 Set [Show Traffic Incident] to "View".

- For details, refer to *Displaying the traffic notification icon* on page 155.

2 Display the map screen.

The icon appears when the system acquires traffic information on the current route.

3 Touch the icon while the icon is displayed.

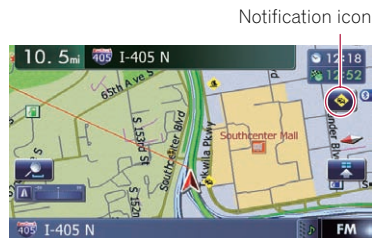

Traffic information on the current route is displayed on the map screen.

Browsing information on MSN Direct

4 Touch [Diversión] to search for an alternative route.

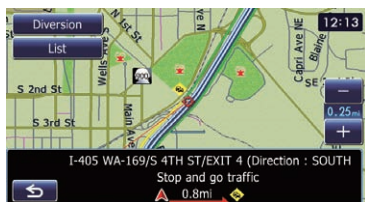

After touching [Diversión], the route is recalculated taking all traffic congestion on your current route into account.

- [Diversión] will be available only when the system can find traffic congestion.
- Notification icon shows the nearest traffic information on the route. However, if you touch [Diversión], the route is recalculated by taking into account not only this information, but also all traffic congestion information on the route.

For the subsequent operations, refer to *Checking for traffic congestion automatically*.

- ➔ For details, refer to *Checking for traffic congestion automatically* on the previous page.

▪ Touch [List].

The "Traffic On Route" screen appears.

- Touch .

The message disappears, and the map screen returns.

Selecting traffic information to display

There are different types of traffic information that can be received via the MSN Direct service, and you can select which types will be incorporated and displayed on your navigation system.

1 Display the "Destination Menu" screen.

- ➔ For details of the operations, refer to *Screen switching overview* on page 22.

2 Touch [MSN Direct].

The "MSN Direct" screen appears.

3 Touch [Traffic Settings].

The "Traffic Settings" screen appears.

4 Touch [Displayed Traffic Information].

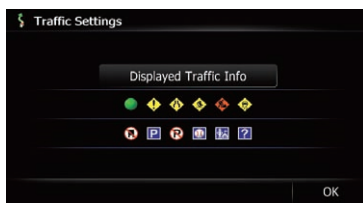

The "Traffic Type Settings" screen appears.

5 Touch the traffic information item to display.

A check mark appears next to the selected traffic information.

- Touch [All] or [None].
Selects or deselects all entries.

6 Touch [OK].



The selected traffic information icon is added to the screen.

7 Touch [OK]. □

Browsing local events

The nearby events to be held in the next few days are displayed on a list, and you can see the detail event information.

Although the MSN Direct service regularly updates local event information, the information provided may not necessarily correspond to actual local event conditions. Please refer to *No notice about MSN Direct* on page 50.

Browsing information on MSN Direct

1 Display the “Destination Menu” screen.

- For details of the operations, refer to *Screen switching overview* on page 22.

2 Touch [MSN Direct].

The “MSN Direct” screen appears.

3 Touch [Local Events].

The “Local Event Date” screen appears.

4 Touch the date on which you want to check the events.

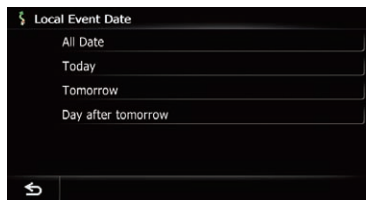

The “Local Event Groups List” screen appears.

5 Touch the category of events that you want to check.

The “Local Event Sub Groups List” screen appears.

6 Touch the subcategory of events that you want to check.

The “Local Events” screen appears. If there is no data, “Unknown” or “-----” is displayed.

7 Touch the desired tab to change the sort order.

Available options:

- **Dist.** (default):
Sorts the items in the list in order by distance from the vehicle position.
- **Name:**
Sorts the items in the list alphabetically.

8 Touch the desired event to display detailed information of the event.

The “Detailed Information” screen appears.

- Touching  allows you to check the location on a map.

- Touch [Refresh].

The information is updated.

- [Refresh] appears when the new information is received.

9 Touch [OK].

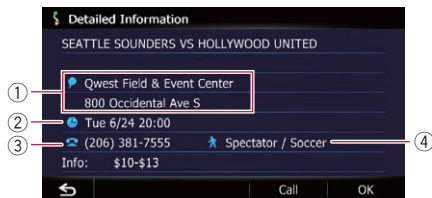

- ① **Address**
- ② **Start date, time and duration**
- ③ **Telephone number**
- ④ **Event name**

- If there is no information available, “-----” is displayed.

Location confirmation screen appears.

- For details, refer to *Setting a route to your destination* on page 41.

- Touch [Call].
Enables you to call the position if a telephone number is available. (Pairing with cellular phone featuring Bluetooth wireless technology is required.)

Browsing news headlines

Recent news headlines are displayed in a list.

Although the MSN Direct service regularly updates news headlines, the information provided may not necessarily correspond to current news headlines. Please refer to *Notice about MSN Direct* on page 50.

1 Display the “Destination Menu” screen.

- For details of the operations, refer to *Screen switching overview* on page 22.

2 Touch [MSN Direct].

The “MSN Direct” screen appears.

Browsing information on MSN Direct

3 Touch [News].

4 Touch the desired news headline.

Further details about the news are displayed.

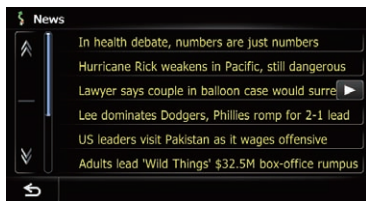

Touch [Refresh].

The information is updated.

- [Refresh] appears when the new information is received.

5 Touch or to scroll the list.

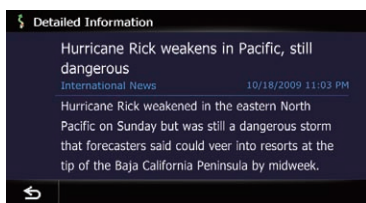

Browsing stock quotes

Recent stock quotes are displayed in a list.

Although the stock quote displayed onscreen is updated about 40 minutes (approx.), these prices are not realtime values. It may take up to 20 minutes for all the data to become available under the following conditions:

- When you use MSN Direct for the first time.
- When you have not performed this function previously around the current area.
- After the navigation system has been turned off for a few days.

Please refer to *Notice about MSN Direct* on page 50.

Selecting stock symbols

Up to 30 stock symbols can be selected.

1 Display the "Destination Menu" screen.

- ☞ For details of the operations, refer to *Screen switching overview* on page 22.

2 Touch [MSN Direct].

The "MSN Direct" screen appears.

3 Touch [Stocks].

The "Stock Info" screen appears.

- The seven stock indices is always selected and displayed on the bottom of the list.

4 Touch [Add].

The "Stock Info" screen appears.

5 Enter the stock symbol that you want to select, and then touch [OK].

The selected stock symbol is added to the "Stock Info" screen.

- If the stock for the selected symbol is not found, a message is displayed. To search again, touch "Yes" and enter the symbol.

Viewing the detailed stock quotes

1 Display the "Destination Menu" screen.

- ☞ For details of the operations, refer to *Screen switching overview* on page 22.

2 Touch [MSN Direct].

The "MSN Direct" screen appears.

3 Touch [Stocks].

The "Stock Info" screen appears.



① Symbol

Displays stock symbols.

② Latest Price

Displays the most recent stock prices.

☐ If there is no data, "-----" is displayed.

③ Change since last closing price

Displays change from the day before.

☐ If there is no data, "-----" is displayed.

④ Timestamp

Displays the time of the latest stock prices.

When the market is closed, "**Market Closed**" is displayed.

☐ If there is no data, "-----" is displayed.

☐ Arrow in the left of each item indicates the stock price movement. If there is no stock price movements than previous close, " " is displayed.

4 Touch the desired stock quote.

Detailed stock quote information is displayed.



- Touch [**Delete**].

The message confirming whether to delete the entry appears.

And then touch [**Yes**] to delete the stock symbol from the "**Stock Info**" screen.

Deleting registered stocks**1 Display the "Destination Menu" screen.**

☞ For details of the operations, refer to *Screen switching overview* on page 22.

2 Touch [MSN Direct].

The "**MSN Direct**" screen appears.

3 Touch [Stocks].**4 Touch the desired stock quote.**

Detailed stock quote information is displayed.

5 Touch [Delete].

The message confirming whether to delete the entry appears.

6 Touch [Yes].

Deletes the stock symbol from the "**Stock Info**" screen. ☐

Registering and connecting a Bluetooth device

If your devices feature Bluetooth® technology, this navigation system can be connected to your devices wirelessly. This section describes how to set up a Bluetooth connection.

For details about the connectivity with the devices featuring Bluetooth wireless technology, refer to the information on our website.

Preparing communication devices

This navigation system has a built in function to use devices featuring Bluetooth wireless technology.

➔ For details, refer to *Notes for hands free phoning* on page 75.

You can register and use devices that feature the following profiles with this navigation system.

- HFP (Hands Free Profile)
 - A2DP (Advanced Audio Distribution Profile)
- ❑ If the registered device features both HFP and A2DP, the hands free connection is made and then the Bluetooth Audio connection is made.
If the registered device features either profile, the corresponding connection is made.
- ❑ When the navigation system is turned off, the Bluetooth connection is also disconnected. When the system restarts, the system automatically attempts to reconnect the previously connected device. Even when the connection is severed for some reason, the system automatically reconnects the specified device (except when the connection is severed due to device operation). ❑

Registering your Bluetooth devices

You need to register your devices featuring Bluetooth wireless technology when you connect it for the first time. A total of 5 devices can be registered. Three registration methods are available:

- Searching for nearby Bluetooth devices
 - Searching for a specified Bluetooth device
 - Pairing from your Bluetooth devices
- ❑ If you try to register more than 5 devices, the system will ask you to select one of the registered devices to delete.
- ➔ For details, refer to *Deleting a registered device* on page 66.

Searching for nearby Bluetooth devices

The system searches for available Bluetooth devices near the navigation system, displays them in a list, and registers them for connection.

1 Activate the Bluetooth wireless technology on your devices.

For some Bluetooth devices, no specific action is necessary to activate Bluetooth wireless technology. For details, refer to the instruction manual of your devices.

2 Display the “Settings Menu” screen.

- ➔ For details of the operations, refer to *Screen switching overview* on page 22.

3 Touch [Bluetooth Settings].

The “Bluetooth Settings” screen appears.

4 Touch [Registration].

The “Nearby Device List” screen appears. The system searches for devices featuring Bluetooth technology that are waiting for the connection and displays them in the list if a device is found.

- ❑ Up to 30 devices will be listed in the order that the devices are found.

5 Wait until your Bluetooth device appears in the list.



- If you cannot find the Bluetooth device that you want to connect, check that the device is waiting for the Bluetooth wireless technology connection.

6 Touch the Bluetooth device name you want to register.



- Touch [Search Again].

The system searches for devices featuring Bluetooth technology that are waiting for the connection and displays them in the list if a device is found.

7 Enter the PIN code (the default PIN code is "1111") using the Bluetooth device.

Enter the PIN code while the message "Please follow the instructions on your mobile phone." appears.

The device is registered in the navigation system.

After the device is successfully registered, the Bluetooth connection is established from the navigation system.

Pairing from your Bluetooth devices

You can register the Bluetooth device by setting the navigation system to standby mode and requesting connection from the Bluetooth device.

1 Activate the Bluetooth wireless technology on your devices.

For some Bluetooth devices, no specific action is necessary to activate Bluetooth wireless technology. For details, refer to the instruction manual of your devices.

2 Display the "Settings Menu" screen.

- For details of the operations, refer to *Screen switching overview* on page 22.

3 Touch [Bluetooth Settings].

The "Bluetooth Settings" screen appears.

4 Touch [Registration].

The "Nearby Device List" screen appears.

5 Touch [Register from mobile phone].

The navigation system waits for a Bluetooth wireless technology connection.

Registering and connecting a Bluetooth device



6 Register the navigation system on your Bluetooth device.

If your device asks you to enter a password, enter the PIN code (password) of the navigation system.

When the device is successfully registered, the connection settings are made from the device.

- ❑ If registration fails, repeat the procedure from the beginning.

Searching for a specified Bluetooth device

If you cannot connect your Bluetooth device using the nearby device search and [**Register from mobile phone**], try this method if your Bluetooth device is found in the list.

1 Activate the Bluetooth wireless technology on your devices.

For some Bluetooth devices, no specific action is necessary to activate Bluetooth wireless technology. For details, refer to the instruction manual of your devices.

2 Display the "Settings Menu" screen.

- ➡ For details of the operations, refer to *Screen switching overview* on page 22.

3 Touch [Bluetooth Settings].

The "**Bluetooth Settings**" screen appears.

4 Touch [Registration].

The "**Nearby Device List**" screen appears.

5 Touch [Select specific devices].

The "**Select specific devices**" screen appears.

6 Touch the Bluetooth device name to be connected.

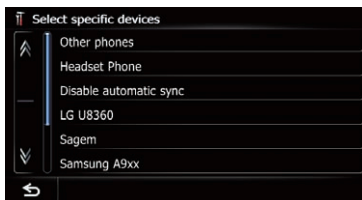

The system searches for devices featuring Bluetooth technology that are waiting for the connection and displays them in the list if a device is found.

- ❑ If you cannot find the desired device name on the list, touch [**Other phones**] to search the devices available nearby.

7 Wait until your Bluetooth device appears in the list.



- ❑ If you cannot find the Bluetooth device that you want to connect, check that the device is waiting for the Bluetooth wireless technology connection.

Registering and connecting a Bluetooth device

8 Touch the Bluetooth device name you want to register.



▪ Touch [Search Again].

The system searches for devices featuring Bluetooth technology that are waiting for the connection and displays them in the list if a device is found.

9 Enter the PIN code (the default PIN code is "1111") using the Bluetooth device. Enter the PIN code while the message "Please follow the instructions on your mobile phone." appears.

The device is registered in the navigation system.

After the device is successfully registered, the Bluetooth connection is established from the navigation system.

Deleting a registered device

When you have already registered 5 Bluetooth devices and you want to add another one, you must first delete one of the registered devices.

- If a registered phone is deleted, all the phone book entries and call history lists that correspond to the phone will be also cleared.

1 Display the "Settings Menu" screen.

- For details of the operations, refer to *Screen switching overview* on page 22.

2 Touch [Bluetooth Settings].

The "Bluetooth Settings" screen appears.

3 Touch [Registration].

A message prompting you to delete a registered device appears.

4 Touch [OK].

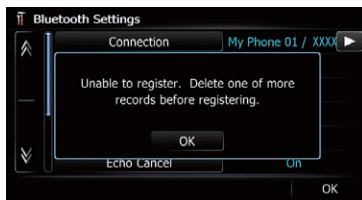

The "Delete from Connection List" screen appears.

5 Touch the Bluetooth device name that you want to delete.



The registration is canceled. □

Connecting a registered Bluetooth device

The navigation system automatically connects the Bluetooth device selected as the target of connection. However, connect the Bluetooth device manually in the following cases:

- Two or more Bluetooth devices are registered, and you want to manually select the device to be used.

Registering and connecting a Bluetooth device

- You want to reconnect a disconnected Bluetooth device.
- Connection cannot be established automatically for some reason.

If you start connection manually, carry out the following procedure. You can also connect the Bluetooth device by having the navigation system detect it automatically.

1 Activate the Bluetooth wireless technology on your devices.

For some Bluetooth devices, no specific action is necessary to activate Bluetooth wireless technology. For details, refer to the instruction manual of your devices.

2 Display the "Settings Menu" screen.

- ➡ For details of the operations, refer to *Screen switching overview* on page 22.

3 Touch [Bluetooth Settings].

The "Bluetooth Settings" screen appears.

4 Touch [Connection].

The "Connection List" screen appears.

5 Touch the name of the device that you want to connect.



The "Select Profile" screen appears.

6 Touch the profile that you want to connect.

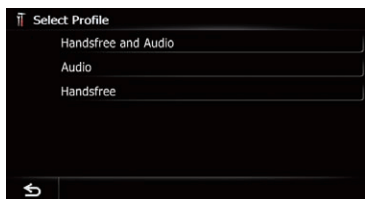

You can select the following profiles:

- **Handsfree and Audio:**
Connects the device as the hands free phone and the Bluetooth audio player.
- **Audio:**
Connects the device as Bluetooth audio player.
- **Handsfree:**
Connects the device as the hands free phone.

Connection starts.



When a connection is successfully established, a connection complete message appears and the map screen returns by touching [OK].

- To cancel the connection to your device, touch [Cancel].
- If connection fails, check whether your device is waiting for a connection and then retry.

Setting for priority connecting

The selected device is set for priority connecting.

And one of the following icons is indicated next to the device name.

- :
Appears when the device is registered so that it will be preferentially paired with both the hand free and Bluetooth audio connection.
- :
Appears when the device is registered so that it can be preferentially paired with the hand free connection.
- :
Appears when the device is registered so that it will be preferentially paired with the Bluetooth audio connection.

⚠ CAUTION

For your safety, avoid talking on the phone as much as possible while driving.

If your cellular phone features Bluetooth technology, this navigation system can be connected to your cellular phone wirelessly. Using this hands free function, you can operate the navigation system to make or receive phone calls. You can also transfer the phone book data stored in your cellular phone to the navigation system. This section describes how to set up a Bluetooth connection and how to operate a cellular phone featuring Bluetooth technology on the navigation system.

For details about the connectivity with the devices featuring Bluetooth wireless technology, refer to the information on our website.

Displaying the Phone Menu

Use the “Phone Menu” if you connect the cellular phone to the navigation system for utilization.

➤ For details of the operation, refer to *Registering and connecting a Bluetooth device* on page 63.

1 Press the HOME button to display the “Top Menu” screen.

2 Touch [Phone].

The “Phone Menu” screen appears.

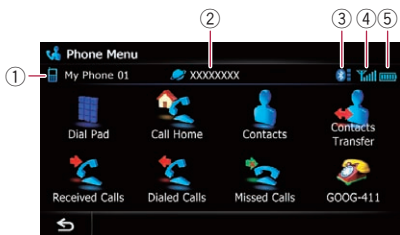

① Name of connected cellular phone

- ② Network name of the cellular phone company
- ③ Strength of the Bluetooth connection between the navigation system and the device
- ④ Reception status of the cellular phone
- ⑤ Battery status of the cellular phone

Making a phone call

You can make a phone call in many different ways.

Direct dialing

1 Display the “Phone Menu” screen.

➤ For details, refer to *Displaying the Phone Menu* on this page.

2 Touch [Dial Pad].

The “Dial Input” screen appears.

3 Touch the number keys to enter the phone number.



The phone number that was input is displayed.

And then [OK] is activated.

▪ Touch .

The input number is deleted a digit at a time from the end of the number. Continuing to press this deletes all of the digits.

▪ Touch .

The previous screen returns.

4 Touch [OK] to make a call.

☐ To cancel the call after the system starts dialing, touch .

5 Touch to end the call.

Using hands-free phoning

Making a call home easily

You can call home without taking the time to enter the phone number if the phone number has been registered.

1 Display the “Phone Menu” screen.

- ➔ For details, refer to *Displaying the Phone Menu* on the previous page.

2 Touch [Call Home].

Dialing home starts.

- ❑ If you have not registered your home number, a message appears. Touch [Register] to start registration.
 - ➔ For details, refer to *Registering your home* on page 152.

Calling a number in the “Contacts List”

After finding the entry you want to call in the “Contacts List” screen, you can select the number and make the call.

- ❑ Before using this function, you need to transfer the phone book entries stored in your cellular phone to the navigation system.
 - ➔ For details, refer to *Transferring the phone book* on page 72.

1 Display the “Phone Menu” screen.

- ➔ For details, refer to *Displaying the Phone Menu* on the previous page.

2 Touch [Contacts].

The “Contacts List” screen appears.

3 Touch [Search].

The “Contacts Name Search” screen appears. You can search by the names registered in the “Contacts List” screen.

4 Switch the page of the list to display the desired entry.



- Touch alphabet tabs.

Makes the screen jump to the beginning of the page including the entry whose names start with any of selected letters or numbers.

Touching [#ABCDE] also displays the page including the entry whose names start with primary symbols or numbers.

Touching [Others] displays the page including entries that are not assigned to any of the other tabs.

5 Touch the desired entry on the list to make a call.

- ❑ If the entry has multiple phone number data, a selection list appears.

6 Touch to end the call.

Dialing from the history

The most recent calls made (dialed), received and missed are stored in the call history list. You can browse the call history list and call numbers from it.

- ❑ Each call history saves 30 calls per registered cellular phone. If the number of calls exceeds 30, the oldest entry will be deleted.

1 Display the “Phone Menu” screen.

- ➔ For details, refer to *Displaying the Phone Menu* on the previous page.

2 Touch [Received Calls], [Dialed Calls] or [Missed Calls].

The selected call history list appears.

3 Touch an entry on the list.

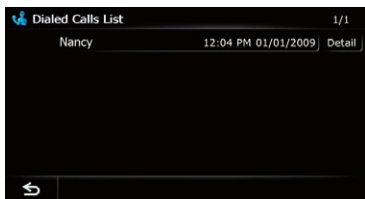

Dialing starts.

- To cancel the call after the system starts dialing, touch .
- Touch **[Detail]**.

The **"Detailed Information"** screen appears.



You can check the details of the party before making a phone call.

4 Touch to end the call.

Dialing GOOG-411

CAUTION

Local and/or long distance charges for making a phone call may apply.

You can dial GOOG 411 to dial the free business listing service of Google™ with one touch.

1 Touch **[GOOG-411]** on the **"Phone Menu"**.

- ⇒ For details, refer to *Displaying the Phone Menu* on page 68.

Dialing GOOG 411 starts.

2 You can now use the **GOOG-411 phone service**.

For details about GOOG 411 service and availability, contact Google.

Dialing the entry stored in the **"Favorites"** list

You can make a call to the entry stored in the **"Favorites"** list.

1 Display the **"Destination Menu"** screen.

- ⇒ For details of the operations, refer to *Screen switching overview* on page 22.

2 Touch **[Favorites]**.

The **"Favorites"** screen appears.

3 Touch next to the location that you want to make a call.

The **"Edit Favorite"** screen appears.

4 Touch **[Call]** to make a call.

To cancel the call after the system starts dialing, touch .

5 Touch to end the call.

Dialing a facility's phone number

You can make a call to facilities with phone number data.

- You cannot make a call to locations or POIs that have no phone number data.

1 Display the **"Destination Menu"** screen.

- ⇒ For details of the operations, refer to *Screen switching overview* on page 22.

2 Touch **[POI]**.

The **"POI Search"** screen appears.

3 Search for the **POI**.

The **"POI List"** screen appears.

- ⇒ For details of the operation, refer to *Searching for Points of Interest (POI)* on page 36.

4 Touch next to the **POI** that you want to call.

The **"Detailed POI Information"** screen appears.

5 Touch **[Call]** to make a call.

To cancel the call after the system starts dialing, touch .

6 Touch to end the call.

Using hands-free phoning

Dialing from the map

You can make a call by selecting the icon of a registered location or a POI icon from the map screen.

- ❑ You cannot make a call to locations or POIs that have no phone number data.

1 Scroll the map, and place the cursor on an icon on the map.

2 Touch .

The “Detailed POI Information” screen appears.

3 Touch [Call] to make a call.

To cancel the call after the system starts dialing, touch .

4 Touch to end the call. .

Receiving a phone call

You can perform hands free answering by using the navigation system.

Answering an incoming call

The system informs you that it is receiving a call by displaying a message and producing a ring sound.

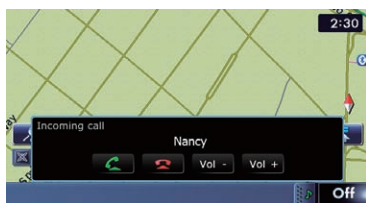

If “Auto Answer Preference” is set to “Off”, answer the call manually. Answering is available if any screen is displayed, such as the map screen or the setting screen.

- ❑ You can set this navigation system to automatically answer incoming calls.
 - For details, refer to *Answering a call automatically* on page 74.

- ❑ The registered name appears if the phone number of the received call is already registered in “Contacts”.
- ❑ Depending on the caller ID service, the phone number of the received call may not be displayed. “Unknown” appears instead.

1 To answer an incoming call, touch .

The operation menu during a call appears.

- Touch [Vol -] or [Vol +].
You can adjust the ring tone volume.
- Touch  to reject an incoming call.
 - ❑ The rejected call is recorded in the missed call history list.
 - For details, refer to *Dialing from the history* on page 69.

2 Touch to end the call.

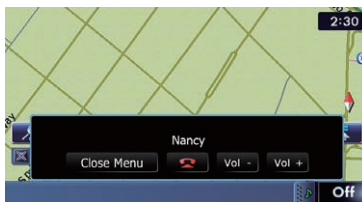

The call ends.



- ❑ If the voice on the other end of the call is too quiet to hear, you can adjust the volume of the received voice.
 - For details, refer to *Setting the Volume for Guidance and Phone* on page 163.
- ❑ You may hear a noise when you hang up the phone.
 - Touch [Vol -] or [Vol +].

You can adjust volume when you are talking.

- Touch [Close Menu].

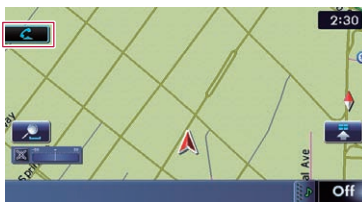
The operation menu during call is minimized.



To display the menu again, touch . .

Transferring the phone book

You can transfer the phone book entries from your cellular phone to the phone book of navigation system.

- ❑ Depending on the cellular phone, Phone Book may be called Contacts, Business card or something else.
- ❑ With some cellular phones, it may not be possible to transfer the entire phone book at once. In this case, transfer addresses one at a time from your phone book using your cellular phone.
- ❑ If you connect the cellular phone featuring auto synchronization function, phone book transfer or synchronization will be automatically performed.
- ❑ A maximum of 1 000 entries can be transferred per cellular phone. If the entries exceed 1 000, the extra entries will not be transferred. If more than one number is registered for one person, such as work place and home, each number may be counted separately.
- ❑ Each entry can hold up to 5 phone numbers.
- ❑ Depending on the cellular phone that is connected to this navigation system via Bluetooth technology, this navigation system may not be able to display the phone book correctly. (Some characters may be garbled.)
- ❑ If the phone book in the cellular phone contains image data, the phone book may not be correctly transferred.
- ❑ The transferred data cannot be edited on the navigation system.

1 Connect the cellular phone that has the phone book to transfer.

- ➔ For details, refer to *Connecting a registered Bluetooth device* on page 66.

2 Touch [Contacts Transfer] on the "Phone Menu" screen.

3 Check that the following screen is displayed, and operate your cellular phone to transfer the phone book entries.

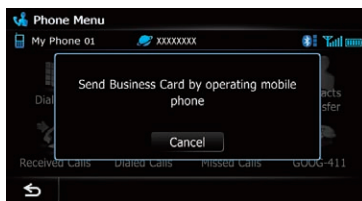

After transferring the data is finished, a message asking whether you want to transfer more data appears.

Touch **[Yes]** to continue the transfer.

4 Touch [No].



The transferred data is imported to the navigation system.

When the data is successfully imported, an import complete message is displayed and the "Contacts List" screen appears.

- ❑ It may take time depending on how many entries will be transferred.

Using hands-free phoning

Deleting registered contacts

1 Display the "Phone Menu" screen.

- ➔ For details, refer to *Displaying the Phone Menu* on page 68.

2 Touch [Contacts].

The "Contacts List" screen appears.

3 Touch [Delete].

The "Delete from Contacts" screen appears.

4 Touch the entry you want to delete.

A check mark appears next to the entry.

- Touch [All] or [None].

Selects or deselects all entries.

5 Touch [Delete].

The message confirming whether to delete the entry appears.

6 Touch [Yes].

The entry is deleted.

- Touch [No].

Cancels the deletion.

Changing the phone settings

Editing the device name

You can change the device name to be displayed on your cellular phone. (Default is "PIONEER NAVI".)

1 Display the "Settings Menu" screen.

- ➔ For details of the operations, refer to *Screen switching overview* on page 22.

2 Touch [Bluetooth Settings].

The "Bluetooth Settings" screen appears.

3 Touch [Device Name].

The keyboard to enter the name appears.

4 Touch to delete the current name, and enter the new name by using the keyboard.



5 Touch [OK].

The name is changed.

- Up to 16 characters can be entered for a device name.

Editing the password

You can change the password to be used for authentication on your cellular phone. (Default is "1111".)

- Four to eight characters can be entered for a password.

1 Display the "Settings Menu" screen.

- ➔ For details of the operations, refer to *Screen switching overview* on page 22.

2 Touch [Bluetooth Settings].

The "Bluetooth Settings" screen appears.

3 Touch [Password].

The "Set Password" screen appears.

4 Touch any key to enter the password you want to set and then touch [OK].

Stopping Bluetooth wave transmission

You can stop transmission of electric waves by turning off the Bluetooth function. If you do not use the Bluetooth wireless technology, we recommend selecting "Off".

1 Display the “Settings Menu” screen.

- For details of the operations, refer to *Screen switching overview* on page 22.

2 Touch [Bluetooth Settings].

The “**Bluetooth Settings**” screen appears.

3 Touch [Bluetooth On/Off].

Touching [**Bluetooth On/Off**] switches between “**On**” and “**Off**”.

Echo canceling and noise reduction

When you are operating hands free phoning in the vehicle, you may hear an undesirable echo. This function reduces the echo and noise while you are using hands free phoning, and maintains a certain sound quality.

1 Display the “Settings Menu” screen.

- For details of the operations, refer to *Screen switching overview* on page 22.

2 Touch [Bluetooth Settings].

The “**Bluetooth Settings**” screen appears.

3 Touch [Echo Cancel].

Touching [**Echo Cancel**] switches between “**On**” and “**Off**”.

Answering a call automatically

The navigation system automatically answers incoming calls to the cellular phone, so you can answer a call while driving without taking your hands off the steering wheel.

1 Display the “Settings Menu” screen.

- For details of the operations, refer to *Screen switching overview* on page 22.

2 Touch [Bluetooth Settings].

The “**Bluetooth Settings**” screen appears.

3 Touch [Auto Answer Preference].

The “**Auto Answer Preference**” screen appears.

4 Touch the desired option.

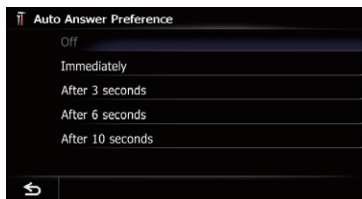

On this screen, you can select the following items:

- **Off:**
No automatic response. Respond manually.
- **Immediately:**
Answers immediately.
- **After 3 seconds:**
Answers after three seconds.
- **After 6 seconds:**
Answers after six seconds.
- **After 10 seconds:**
Answers after ten seconds.

Setting the automatic rejection function

If this function is on, the navigation system automatically rejects all incoming calls.

1 Display the “Settings Menu” screen.

- For details of the operations, refer to *Screen switching overview* on page 22.

2 Touch [Bluetooth Settings].

The “**Bluetooth Settings**” screen appears.

3 Touch [Refuse All Calls].

Touching [**Refuse All Calls**] switches between “**On**” and “**Off**”.

- If both “**Refuse All Calls**” and “**Auto Answer Preference**” are activated, “**Refuse All Calls**” takes priority and all incoming calls are automatically rejected.
- If “**Refuse All Calls**” is set to “**On**”, rejected incoming calls will not be stored in the missed call list.

Using hands-free phoning

Clearing memory

You can clear the memory of each item that corresponds to the connected cellular phone: phone book, dialed/received/missed call history list and preset dials.

1 Display the “Settings Menu” screen.

- For details of the operations, refer to *Screen switching overview* on page 22.

2 Touch [Bluetooth Settings].

The “Bluetooth Settings” screen appears.

3 Touch [Clear Memory].

The “Clear Memory” screen appears.



On this screen, you can select the following items:

- **Contacts:**
You can clear the registered phone book.
- **Received Calls List:**
You can clear the received call history list.
- **Dialed Calls List:**
You can clear the dialed call history list.
- **Missed Calls List:**
You can clear the missed call history list.

▪ Touch [Clear All].

It clears all the data that correspond to the connected cellular phone.

4 Touch [Yes].

Data on the selected item is cleared from this navigation system’s memory.

- If you do not want to clear the memory that you have selected, touch [No].

Updating the Bluetooth wireless technology software

Update files will be available for download in the future. You will be able to download the latest update from an appropriate website to your PC.

- Before you download the files and install the update, read through the instructions on the website. Follow the instructions on the website for steps until [Firmware update] becomes active.

1 Insert an SD memory card into the SD card slot.

- For details of the operation, refer to *Inserting and ejecting an SD memory card* on page 15.

2 Display the “Settings Menu” screen.

- For details of the operations, refer to *Screen switching overview* on page 22.

3 Touch [Bluetooth Settings].

The “Bluetooth Settings” screen appears.

4 Touch [Firmware update].

The current version is displayed.

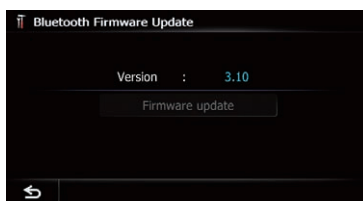

5 Touch [Firmware update].

Update starts. □

Notes for hands-free phoning

General notes

- Connection to all cellular phones featuring Bluetooth wireless technology is not guaranteed.

- The line of sight distance between this navigation system and your cellular phone must be 10 meters or less when sending and receiving voice and data via Bluetooth technology. However, the actual transmission distance may be shorter than the estimated distance, depending on the usage environment.
- With some cellular phones, the ring sound may not be output from the speakers.
- If private mode is selected on the cellular phone, hands free phoning may be disabled.

Registration and connection

- Cellular phone operations vary depending on the type of cellular phone. Refer to the instruction manual that came with your cellular phone for detailed instructions.
- With cellular phones, phone book transfer may not work even though your phone is paired with the navigation system. In that case, disconnect your phone, perform pairing again from your phone to the navigation system, and then perform the phone book transfer.

Making and receiving calls

- You may hear a noise in the following situations:
 - When you answer the phone by using the button on the phone.
 - When the person on the other end of line hangs up the phone.
- If the person on the other end of the phone call cannot hear the conversation due to an echo, decrease the volume level for hands free phoning. This may reduce the echo.
- With some cellular phones, even if you press the accept button on the cellular phone when a call comes in, hands free phoning may not be performed.
- The registered name appears if the phone number of the received call is already registered in the phone book. When one phone number is registered under different

names, the name that comes first in the phone book is displayed.

- If the phone number of the received call is not registered in the phone book, the phone number of the received call appears.

The received call history and the dialed number history

- Calls made or editing performed only on your cellular phone will not be reflected to the dialed number history or phone book in the navigation system.
- You cannot make a call to the entry of an unknown user (no phone number) in the received call history.
- If calls are made by operating your cellular phone, no history data will be recorded in the navigation system.

Phone book transfers

- If there are more than 1 000 phone book entries on your cellular phone, all entries may not be downloaded completely.
- With some cellular phones, it may not be possible to transfer all items in the phone book at one time. In this case, transfer items one by one from your cellular phone.
- Depending on the cellular phone, this navigation system may not display the phone book correctly. (Some characters may be garbled, or first and last names may be reversed.)
- If the phone book in the cellular phone contains image data, the phone book may not be transferred correctly. (Image data can not be transferred from the cellular phone.)
- Depending on the cellular phone, phone book transfer may not be available.

Basic operations of the AV source

This chapter describes the basic operations of the AV source.

You can play or use the following sources with the navigation system.

- TUNER (FM, AM)
- CD
- ROM (in MP3, AAC, WMA)
- DVD Video
- DivX
- USB
- SD

The following sources can be played back or used by connecting an auxiliary device.

- HD Radio (HD Radio tuner)
- iPod
- Pandora
- Bluetooth Audio
- XM Tuner
- SIRIUS Tuner
- AV input 1 (AV1)
- AV input 2 (AV2)
- External unit 1 (EXT1)
- External unit 2 (EXT2)

Displaying the AV operation screen

- Press the **MODE** button when the map screen is displayed.

- The AV operation screen can also be displayed by touching **[AV Source]** on the "Top Menu".

Selecting a source

Source icon



- 1 **Drag a source icon up or down.**

The AV source icons scroll, and hidden icons appear.

- 2 **Tap the icon of the source you want to select.**

The operation screen of the selected source appears.

- The icon currently selected is highlighted. □

Operating list screens (e.g. iPod list screen)

This describes the operations when a list screen is displayed.

- For displaying the list screen, refer to the description of the corresponding source.

Switching between the AV operation screen and the list screen

The following example describes how to switch between the AV operation screen and the artist list screen of iPod.

- 1 **Touch the appropriate key to display the list that you want.**

- For displaying the list screen, refer to the description of the corresponding source.



- 2 Touch the key on the right edge of the screen.

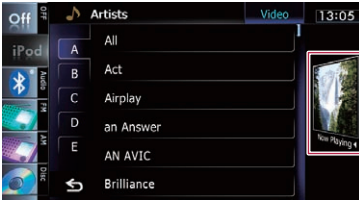

The AV operation screen returns.

Selecting an item

- 1 Scroll by dragging items up or down, and display the item you want to select.

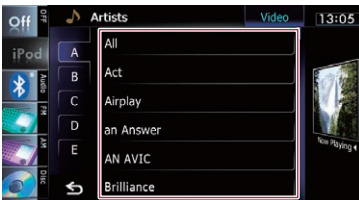

- Flicking a list item enables you to quickly scroll through the list.
To stop scrolling, gently touch the list.
- 2 Tap the item.
 - The item currently selected is highlighted.

Returning to the previous display

- Touch  to return to the previous screen.

Using the radio (FM)

You can listen to the radio by using the navigation system. This section describes operations for radio (FM).

Starting procedure

1 Display the AV operation screen.

- For details of the operations, refer to *Dis playing the AV operation screen* on page 77.

2 Tap [FM] on the left edge of the screen to display the "FM" screen.

3 Use the touch panel keys on the screen to control the radio.

- For details, refer to *Using the touch panel keys* on the next page.

⑧ Program service name or frequency indicator

Shows the frequency of the preset item. If the program service name can be obtained, the program service name is shown instead of the frequency.

⑨ Preset number indicator

Shows what preset item has been selected.

Reading the screen

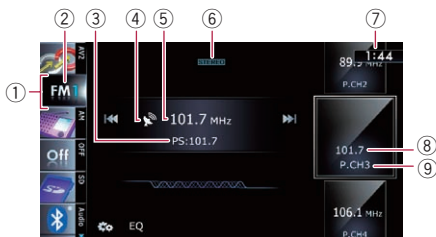

① Source icon

Shows which source has been selected.

② Band indicator

Shows which band the radio is tuned to: FM1 to FM3.

③ Program service name indicator

Shows the program service name (station name) of the current station.

④ Signal level indicator

⑤ Frequency indicator

⑥ STEREO indicator

Shows that the frequency selected is being broadcast in stereo.

⑦ Current time

Using the touch panel keys

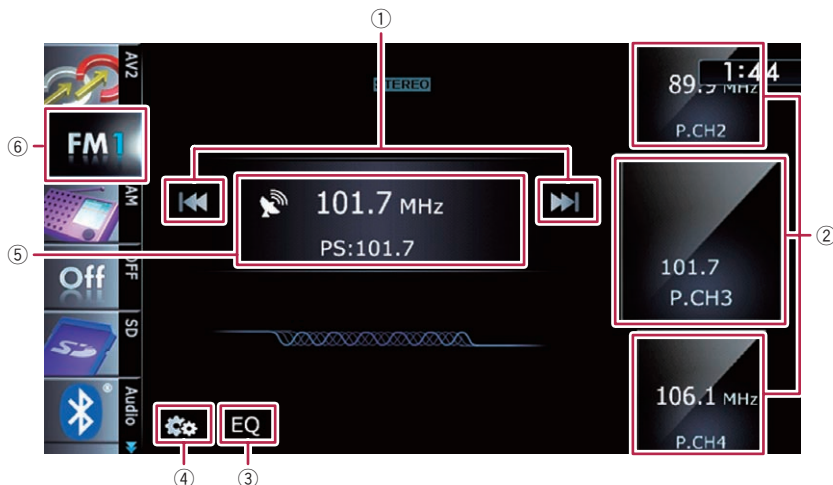

① Performs manual tuning

To tune manually, touch [◀◀] or [▶▶] briefly. The frequencies move up or down one step at a time.

Performs seek tuning

To perform seek tuning, touch and hold [◀◀] or [▶▶] for about one second and release. The tuner will scan frequencies until a broadcast strong enough for good reception is found.

- You can cancel seek tuning by touching either [◀◀] or [▶▶] briefly.
- If you touch and hold [◀◀] or [▶▶], you can skip broadcasting frequencies. Seek tuning will start as soon as you release the keys.
- You can also perform these operations by using the **TRK** button.

② Selects a preset channel

The keys can be used to switch preset channels.

Scroll by dragging the keys up or down to display the preset channel you want to select, and tap the channel.

- The lower key and the upper key appear only when the preset channel is selected.

③ Recalls equalizer curves

- ➔ For details, refer to *Using the equalizer* on page 172.

④ Displays the “Function” menu

- ➔ For details, refer to *Using the “Function” menu* on the next page.

⑤ Switches between the AV operation screen and the preset list display

You can switch the screen display according to your preference.

- ➔ For details of the operation, refer to *Switching between the AV operation screen and the list screen* on page 77.

⑥ Selects an FM band

Tapping the key repeatedly switches between the following FM bands: **FM1**, **FM2**, or **FM3**.

- This function is convenient for preparing different preset lists for each band.

Storing and recalling broadcast frequencies

With a tap of any of the preset tuning keys (“P1” to “P6”), you can easily store up to six broadcast frequencies for later recall (also with the tap of a key).

Using the radio (FM)

- 1 Select a frequency that you want to store in memory.
- 2 Display the preset channel list.
 - For details, refer to *Switches between the AV operation screen and the preset list display* on the previous page.
- 3 Keep touching a preset tuning key [P1] to [P6].

Preset list display



Preset tuning keys

- For details of the list operations, refer to *Operating list screens (e.g. iPod list screen)* on page 77.

The selected radio station has been stored in memory.

The next time you tap the same preset tuning key "P1" to "P6", the radio station frequencies are recalled from memory.

- Up to 18 FM stations, six for each of the three FM bands, as well as six AM stations, can be stored in memory.

Using the "Function" menu

- Touch  on the "FM" screen.

The "Function" menu appears.

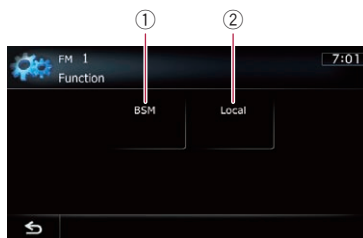

- 1 Stores the strongest broadcast frequencies
- 2 Tunes in strong signals
 - For details of each function, refer to sections below with the relative titles.

Storing the strongest broadcast frequencies

BSM (best stations memory) lets you automatically store the six strongest broadcast frequencies under the preset tuning keys "P1" to "P6" and, once stored there, you can tune in to these frequencies with the touch of a key.

- 1 Touch  on the "FM" screen.

- 2 Touch [BSM].

- 3 Touch [Start] to begin a search.

BSM begins to flash. While "BSM" is flashing, the six strongest broadcast frequencies will be stored under the preset tuning keys "P1" to "P6" in order of their signal strength. When this is complete, "BSM" stops flashing.

- To cancel the storage process, touch [Stop].
- Storing broadcast frequencies with BSM may replace broadcast frequencies you have already saved.

Tuning in strong signals

Local seek tuning allows you to tune in only those radio stations with sufficiently strong signals for good reception.

Using the radio (FM)

- 1 Touch  on the "FM" screen.
- 2 Touch [Local].
- 3 Touch [On] to turn local seek tuning on.
To turn local seek tuning off, touch [Off].
- 4 Touch [◀Prev] or [Next▶] to set the sensitivity.

There are four levels of sensitivity for FM.

Level: **1** **2** **3** **4**

- The level "4" setting allows reception of only the strongest stations, while lower settings let you receive weaker stations.

Using the radio (AM)

You can listen to the radio using this navigation system. This section describes operations for radio (AM).

Starting procedure

1 Display the AV operation screen.

- For details of the operations, refer to *Displaying the AV operation screen* on page 77.

2 Tap [AM] on the left edge of the screen to display the "AM" screen.

3 Use the touch panel keys on the screen to control the radio.

- For details, refer to *Using the touch panel keys* on the next page. ■

Reading the screen

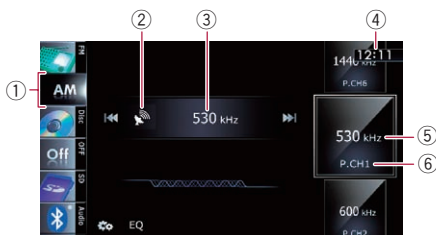

- ① **Source icon**
Shows which source has been selected.
- ② **Signal level indicator**
- ③ **Frequency indicator**
- ④ **Current time**
- ⑤ **Frequency indicator**
Shows the frequency of the preset item.
- ⑥ **Preset number indicator**
Shows what preset item has been selected. ■

Using the touch panel keys

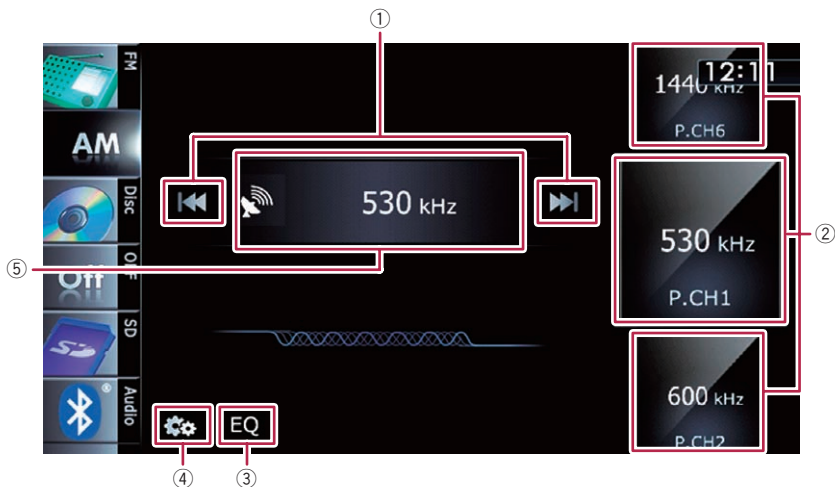

① Performs manual tuning

To tune manually, touch [◀◀] or [▶▶] briefly. The frequencies move up or down one step at a time.

Performs seek tuning

To perform seek tuning, touch and hold [◀◀] or [▶▶] for about one second and release. The tuner will scan frequencies until a broadcast strong enough for good reception is found.

- You can cancel seek tuning by touching either [◀◀] or [▶▶] briefly.
- If you touch and hold [◀◀] or [▶▶], you can skip broadcasting frequencies. Seek tuning will start as soon as you release the keys.
- You can also perform these operations by using the **TRK** button.

② Selects a preset channel

The keys can be used to switch preset channels.

Scroll by dragging the keys up or down to display the preset channel you want to select, and tap the channel.

- The lower key and the upper key appear only when the preset channel is selected.

③ Recalls equalizer curves

- ➔ For details, refer to *Using the equalizer* on page 172.

④ Displays the “Function” menu

- ➔ For details, refer to *Using the “Function” menu* on the next page.

⑤ Switches between the AV operation screen and the preset list display

You can switch the screen display according to your preference.

- ➔ For details of the operation, refer to *Switching between the AV operation screen and the list screen* on page 77.

Storing and recalling broadcast frequencies

With a tap of any of the preset tuning keys (“P1” to “P6”), you can easily store up to six broadcast frequencies for later recall (also with the tap of a key).

1 Select a frequency that you want to store in memory.

Using the radio (AM)

2 Display the preset channel list.

- ➔ For details, refer to *Switches between the AV operation screen and the preset list display* on the previous page.

3 Keep touching a preset tuning key [P1] to [P6].

Preset list display

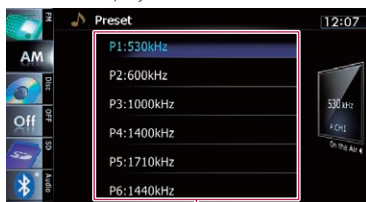

Preset tuning keys

- ➔ For details of the list operations, refer to *Operating list screens (e.g. iPod list screen)* on page 77.

The selected radio station has been stored in memory.

The next time you tap the same preset tuning key "P1" to "P6", the radio station frequencies are recalled from memory.

Using the "Function" menu

- Touch  on the "AM" screen.

The "Function" menu appears.

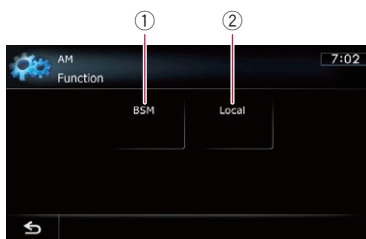

- ① Stores the strongest broadcast frequencies

- ② Tunes in strong signals

- ➔ For details of each function, refer to sections below with the relative titles.

Stores the strongest broadcast frequencies

BSM (best stations memory) lets you automatically store the six strongest broadcast frequencies under the preset tuning keys "P1" to "P6" and, once stored there, you can tune in to these frequencies with the touch of a key.

- 1 Touch  on the "AM" screen.

- 2 Touch [BSM].

- 3 Touch [Start] to begin a search.

BSM begins to flash. While "BSM" is flashing, the six strongest broadcast frequencies will be stored under the preset tuning keys "P1" to "P6" in order of their signal strength. When this is complete, "BSM" stops flashing.

- To cancel the storage process, touch [Stop].
- Storing broadcast frequencies with BSM may replace broadcast frequencies you have already saved.

Tunes in strong signals

Local seek tuning allows you to tune in only those radio stations with sufficiently strong signals for good reception.

- 1 Touch  on the "AM" screen.

- 2 Touch [Local].

- 3 Touch [On] to turn local seek tuning on. To turn local seek tuning off, touch [Off].

- 4 Touch [◀Prev] or [Next▶] to set the sensitivity.

There are two levels of sensitivity for AM.

Level: 1 2

- The level "2" setting allows reception of only the strongest stations, while lower settings let you receive weaker stations.

You can listen to the radio by using the navigation system. This section describes operations for HD Radio reception.

- ❑ You have to connect an HD Radio tuner (e.g. GEX P20HD) (sold separately) to enable reception of HD Radio broadcasts on this navigation system.

For details concerning operation, refer to the HD Radio tuner's operation manual.

Starting procedure

1 Display the AV operation screen.

- ➔ For details of the operations, refer to *Displaying the AV operation screen* on page 77.

2 Tap [Digital Radio] on the left edge of the screen to display the "Digital Radio" screen.

3 Use the touch panel keys on the screen to control the radio.

- ➔ For details, refer to *Using the touch panel keys* on the next page. ■

Reading the screen

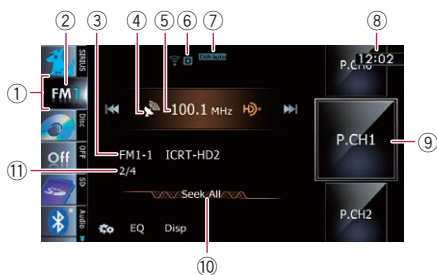

1 Source icon

Shows which source has been selected.

2 Band indicator

Shows which band the radio is tuned to: FM1, FM2, FM3 or AM.

3 Detailed information

➔ For details, refer to *Switching the display* on page 88.

4 Signal level indicator

5 Frequency indicator

6 Signal type indicator

Shows the type of signal currently being received. If a digital broadcasting is received, "D" appears. Otherwise, "A" appears.

7 Blending mode indicator

➔ For details, refer to *Switching the reception mode* on page 89.

8 Current time

9 Preset number indicator

Shows what preset item has been selected.

10 Seek type indicator

➔ For details, refer to *Switching the seek mode* on page 89.

11 Multicasting indicator

Shows the number of multicast channels in the current frequency. ■

Using the touch panel keys

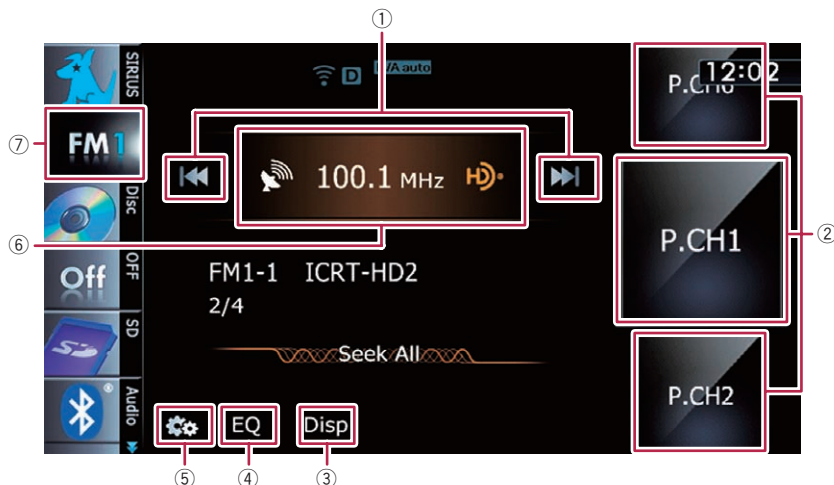

① Performs manual tuning

To tune manually, touch [◀◀] or [▶▶] briefly. The frequencies move up or down one step at a time.

Performs seek tuning

To perform seek tuning, touch and hold [◀◀] or [▶▶] for about one second and release. The tuner will scan frequencies until a broadcast strong enough for good reception is found.

- You can cancel seek tuning by touching either [◀◀] or [▶▶] briefly.
- If you touch and hold [◀◀] or [▶▶], you can skip broadcasting frequencies. Seek tuning will start as soon as you release the keys.
- You can also perform these operations by using the **TRK** button.

② Selects a preset channel

The keys can be used to switch preset channels.

Scroll by dragging the keys up or down to display the preset channel you want to select, and tap the channel.

③ Switches the display

- ➔ For details, refer to *Switching the display* on the next page.

④ Recalls equalizer curves

- ➔ For details, refer to *Using the equalizer* on page 172.

⑤ Displays the “Function” menu

- ➔ For details, refer to *Using the “Function” menu* on the next page.

⑥ Switches between the AV operation screen and the preset list display

You can switch the screen display according to your preference.

- ➔ For details of the operation, refer to *Switching between the AV operation screen and the list screen* on page 77.

⑦ Selects a band

Tap the key repeatedly until the desired band is displayed: **FM1**, **FM2**, **FM3**, or **AM**.

- This function is convenient for preparing different preset lists for each band.

Storing and recalling broadcast frequencies

With a tap of any of the preset tuning keys (“Preset 1” to “Preset 6”), you can easily store up to six broadcast frequencies for later recall (also with the tap of a key).

- 1 Select a frequency that you want to store in memory.
- 2 Display the preset channel list.
 - ➔ For details, refer to *Switches between the AV operation screen and the preset list display* on the previous page.
- 3 Keep touching a preset tuning key [Preset 1] to [Preset 6].

Preset list display

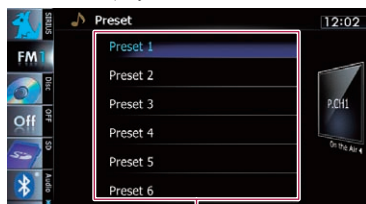

Preset tuning keys

- ➔ For details, refer to *Operating list screens (e.g. iPod list screen)* on page 77.
- The selected radio station has been stored in memory.
- The next time you tap the same preset tuning key "Preset 1" to "Preset 6", the radio station frequencies are recalled from memory.
- ❑ Up to 18 FM stations, six for each of the three FM bands, as well as six AM stations, can be stored in memory.

Switching the display

Desired information can be displayed.

● Touch [Disp].

Touch [Disp] repeatedly to switch between the following settings:

Channel name Artist name Song title
Program type

- ❑ Only when the tuner has been tuned in to an HD Radio station, can the display be changed.
- ❑ When the tuner has been tuned in to an HD Radio station, default display is changed into station name instead of frequency.

Scrolling the detailed information

You can turn the detailed information scroll mode on and off.

- Touch and hold [Disp].

Using the "Function" menu

- Touch on the "Digital Radio" screen. The "Function" menu appears.

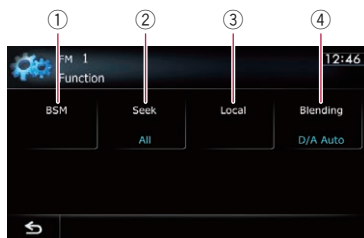

- ① Stores the strongest broadcast frequencies
 - ② Switches the seek mode
 - ③ Tunes in strong signals
 - ④ Switches the reception mode
- ➔ For details of each function, refer to sections below with the relative titles.

Storing the strongest broadcast frequencies

BSM (best stations memory) lets you automatically store the six strongest broadcast frequencies under the preset tuning keys "Preset 1" to "Preset 6" and, once stored there, you can tune in to these frequencies with the touch of a key.

- 1 Touch on the "Digital Radio" screen.
- 2 Touch [BSM].

HD Radio™ reception

3 Touch [Start] to begin a search.

BSM begins to flash. While “BSM” is flashing, the six strongest broadcast frequencies will be stored under the preset tuning keys “Preset 1” to “Preset 6” in order of their signal strength. When this is complete, “BSM” stops flashing.

- To cancel the storage process, touch [Stop].
- Storing broadcast frequencies with BSM may replace broadcast frequencies you have already saved.

Switching the seek mode

You can select the method of seek tuning.

1 Touch on the “Digital Radio” screen.

2 Touch [Seek] to select the desired setting.

- **All:**
Seeks stations from both analog and digital broadcasting.
- **HD:**
Seeks from digital broadcasting only.
- If you select “HD” on this setting while [Blending] is set to “Analog”, the setting on [Blending] turns to “D/A Auto” automatically.

Tuning in strong signals

Local seek tuning allows you to tune in only those radio stations with sufficiently strong signals for good reception.

1 Touch on the “Digital Radio” screen.

2 Touch [Local].

3 Touch [On] to turn local seek tuning on.

To turn local seek tuning off, touch [Off].

4 Touch [◀Prev] or [Next▶] to set the sensitivity.

There are four levels of sensitivity for FM and two levels for AM:

FM: 1 2 3 4

AM: 1 2

- The FM “4” (AM “2”) setting allows reception of only the strongest stations, while lower settings let you receive weaker stations.

Switching the reception mode

If a digital broadcast reception condition gets poor, the tuner automatically switches to the analog broadcast of the same frequency level in default. If you want to prevent a frequent automatic switching, switch this setting to [Analog].

1 Touch on the “Digital Radio” screen.

2 Touch [Blending] to switch the reception mode.

- **Analog:**
Receives analog broadcasting only.
- **D/A Auto:**
Automatically switches to the analog broadcast of the same frequency level as the digital broadcast.
- If you select “Analog” on this setting while [Seek] is set to “HD”, the setting on [Seek] turns to “All” automatically.

You can play a normal music CD using the built-in drive of the navigation system. This section describes how.

Starting procedure

1 Display the AV operation screen.

- For details of the operations, refer to *Displaying the AV operation screen* on page 77.

2 Insert the disc you want to play into disc-loading slot.

Playback starts from the first track of the CD.

- For details of the operation, refer to *Inserting and ejecting a disc* on page 14.
- If the disc is already set, tap [Disc] on the left edge of the screen.
- For details, refer to **Selecting a source** on page 77.

3 Use the touch panel keys on the screen to control the disc.

- For details, refer to *Using the touch panel keys* on the next page.

Reading the screen

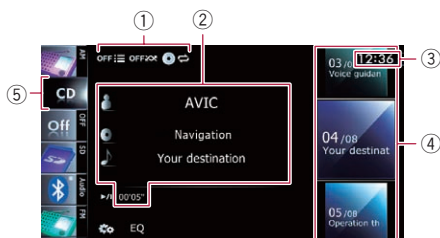

① Playback condition indicator

Indicates the current playback condition.

- Scanning tracks of a CD

Indicator:	Meaning
	Cancels the scan play.
	Plays the beginning of each track in the current repeat play range for about 10 seconds.

- Playing tracks in random order

Indicator:	Meaning
	Does not play tracks in random order.
	Plays all tracks in the current disc in random order.

- Setting a repeat play range

Indicator:	Meaning
	Repeats the current disc.
	Repeats just the current track.

② Current track information

- : **Artist name**
Shows the artist name of the track currently playing (when available).
- : **Album title**
Shows the title of the album for the current track (when available).
- : **Track title**
Shows the title of the track currently playing (when available).
- Play time**
Shows the elapsed playing time within the current track.
- "-----" is displayed if there is no corresponding information.

③ Current time

④ Track information

- Track number indicator**
Shows the track number and the total number of tracks in the current repeat range.
- Track title indicator**

⑤ Source icon

Shows which source has been selected.

Playing audio CDs

Using the touch panel keys

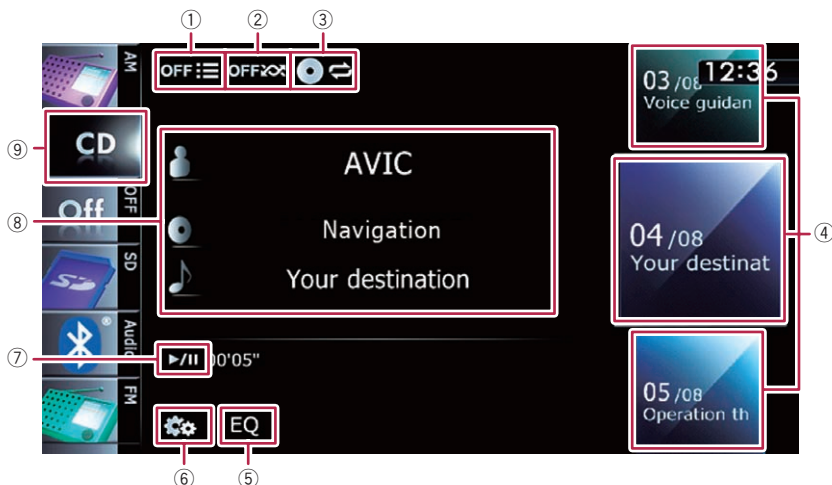

① Scans tracks of a CD

Scan play is performed by touching only one key.

➔ For details of the operation, refer to **Scans tracks of a CD** on the next page.

② Plays tracks in random order

All of the tracks in the disc can be played at random by touching only one key.

➔ For details of the operation, refer to **Plays tracks in random order** on the next page.

③ Sets a repeat play range

The repeat play range can be changed by touching only one key.

➔ For details, refer to **Changes the repeat range** on the next page.

④ Selects a track to play

Scrolling the keys up or down displays tracks, and tapping a track starts playback.

Tapping the lower key during random playback skips to the next track. Tapping the upper key jumps to the start of the current track.

⑤ Recalls equalizer curves

➔ For details, refer to **Using the equalizer** on page 172.

⑥ Displays the "Function" menu

➔ For details, refer to **Using the "Function" menu** on the next page.

⑦ Playback and Pause

Touching [▶/⏸] switches between playback and pause.

⑧ Selects a track from the list

Touching the key displays the list which lets you see the list of track titles on a disc. You can play a track on the list by tapping it.

□ "-----" is displayed if there is no corresponding information.

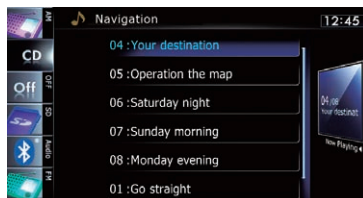

➔ For details, refer to **Operating list screens (e.g. iPod list screen)** on page 77.

⑨ Switches the media file type played

➔ For details, refer to **Switches the media file type played** on page 96. □

Using the “Function” menu

- Touch  on the “CD” screen.

The “Function” menu appears.

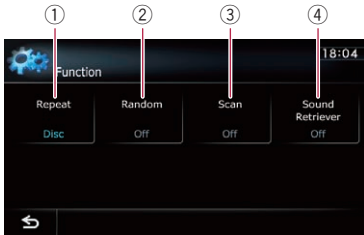

① Changes the repeat range

Each touch of [**Repeat**] changes the setting as follows:

- **Disc**: Repeats the current disc.
- **Track**: Repeats just the current track.
- If you perform track search or fast forward or reverse, track repeat playback is automatically canceled.

② Plays tracks in random order

Each touch of [**Random**] turns it on or off.

- If you turn the random play on when the repeat play range is set to “**Track**”, the repeat play range changes to “**Disc**” automatically.

③ Scans tracks of a CD

Each touch of [**Scan**] turns it on or off. Scan play lets you hear the first 10 seconds of each track on the CD. When you find the track you want, touch [**Scan**] to turn scan play off.

- After scanning is finished, normal playback of the tracks will begin again.
- If you turn the scan play on when the repeat play range is set to “**Track**”, the repeat play range changes to “**Disc**” automatically.

④ Uses “Sound Retriever” function

“**Sound Retriever**” function automatically enhances compressed audio and restores rich sound.

Each touch of [**Sound Retriever**] changes the setting as follows:

- **MODE 1**: Activates “**Sound Retriever**” function.
- **MODE 2**: Activates “**Sound Retriever**” function.
- **Off**: Deactivates “**Sound Retriever**” function.
- **MODE 2** has a stronger effect than **MODE 1** and is more effective when playing back highly compressed audio data. 

Playing music files on ROM

You can play a disc that contains compressed audio files using the built in drive of the navigation system. This section describes these operations.

- In the following description, the MP3, WMA, AAC files are collectively referred to as “Compressed audio file”.

Starting procedure

1 Display the AV operation screen.

- ➔ For details of the operations, refer to *Displaying the AV operation screen* on page 77.

2 Insert the disc you want to play into disc-loading slot.

Playback starts from the first file of the ROM.

- ➔ For details of the operation, refer to *Inserting and ejecting a disc* on page 14.
- If the disc is already set, tap [Disc] on the left edge of the screen.
- ➔ For details, refer to *Selecting a source* on page 77.

3 Use the touch panel keys on the screen to control the disc.

- ➔ For details concerning operations, refer to *Using the touch panel keys* on page 95. 

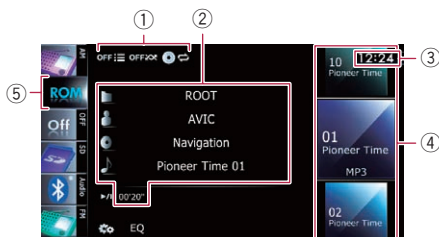

Reading the screen



① Playback condition indicator



- Indicates the current playback condition.
 - Scanning folders and files

Indicator: Meaning

	Cancels the scan play.
	Plays the first audio files of each folder for about 10 seconds when the repeat range is set to “Disc”. Plays the beginning of each audio file in the current folder when the repeat range is set to “Folder”.



- Playing files in random order

Indicator: Meaning





	Does not play tracks in random order.
	Plays all audio files in the current repeat play range in random order.

- Setting a repeat play range

Indicator: Meaning

	Repeats all compressed audio files.
	Repeats just the current file.
	Repeats the current folder.

② Current file information

- : **Folder name**
Shows the folder name currently playing.
- : **Artist name**
Shows the artist name currently playing (when available).
- : **Album title**
Shows the title of the album for the current file (when available).
- : **Track title**
Shows the title of the track currently playing (when available).
□ If the title of a track is not available, the file name appears.
- **Play time**
Shows the elapsed playing time within the current file.

□ "-----" is displayed if there is no corresponding information.

③ **Current time**

④ **File information**

- **File number indicator**
- **File name indicator**
- **File type indicator**

Shows the type of audio file.

⑤ **Source icon**

Shows which source has been selected. 

Playing music files on ROM

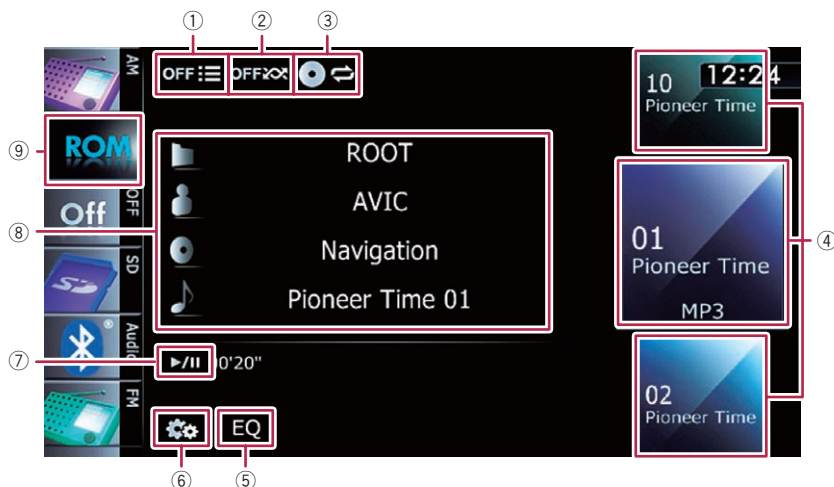

Using the touch panel keys

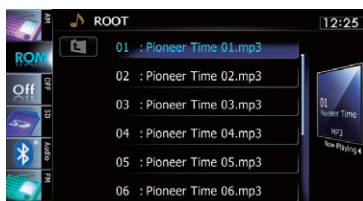

- ① **Scans folders and files**
Scan play is performed by touching only one key.
 - ➔ For details of the operation, refer to **Scans folders and files** on the next page.
- ② **Plays files in random order**
The files in the current repeat play range can be played at random by touching only one key.
 - ☐ If the disc contains a mixture of various media file types, all tracks or files within the current part ("CD" or "ROM") are played randomly.
 - ➔ For details, refer to **Plays files in random order** on the next page.
- ③ **Sets a repeat play range**
The repeat play range can be changed by touching only one key.
 - ➔ For details, refer to **Changes the repeat range** on the next page.
- ④ **Selects a file to play**
Scrolling the keys up or down displays files, and tapping a file starts playback. Tapping the lower key during random play back skips to the next file. Tapping the upper key jumps to the start of the current file.
- ⑤ **Recalls equalizer curves**
 - ➔ For details, refer to *Using the equalizer* on page 172.
- ⑥ **Displays the "Function" menu**
 - ➔ For details, refer to *Using the "Function" menu* on the next page.
- ⑦ **Playback and Pause**
Touching [▶/⏸] switches between playback and pause.
- ⑧ **Selects a file from the list**
Touching the key displays the list which lets you see the list of track titles or folder names on a disc.
 - ☐ If the title of a track is not available, the file name appears.
 Tapping a folder on the list shows its content. You can play a file on the list by tapping it.



- ➔ For details, refer to *Operating list screens (e.g. iPod list screen)* on page 77.

Touching  displays the content of the upper folder (parent folder). If the uppermost folder is listed,  cannot be used.

⑨ Switches the media file type played

When playing a disc containing a mixture of various media file types, you can switch between media file types to play.

Tap the key repeatedly to switch between the following media file types:

CD (audio data (CD DA)) **ROM** (compressed audio file) **DivX** (DivX video files) 

Using the “Function” menu

● Touch on the “ROM” screen.

The “Function” menu appears.



① Changes the repeat range

Each touch of [**Repeat**] changes the setting as follows:

- **Disc:** Repeats all compressed audio files.
 - **Track:** Repeats just the current file.
 - **Folder:** Repeats the current folder.
- If you select another folder during repeat play, the repeat play range changes to “**Disc**”.
 - If you perform fast reverse or fast forward during “**Track**”, the repeat play range changes to “**Folder**”.
 - When “**Folder**” is selected, it is not possible to playback a subfolder of that folder.
 - When playing discs with compressed audio files and audio data (CD DA), repeat play is performed within the cur

rently playing data session even if “**Disc**” is selected.

② Plays files in random order

Each touch of [**Random**] turns it on or off. When the random play is turned on, the files in the current repeat play range are randomly played.

- If you turn the random play on when the repeat play range is set to “**Track**”, the repeat play range changes to “**Folder**” automatically.

③ Scans folders and files

Scan play lets you hear the first 10 seconds of each file. Scan play is performed in the current repeat play range.

Each touch of [**Scan**] turns it on or off.

When you find the track you want, touch [**Scan**] to turn the scan play off.

- After completion of file or folder scanning, normal playback of the files will begin again.
- If you turn the scan play on when the repeat play range is set to “**Track**”, the repeat play range changes to “**Folder**” automatically.
- If you turn the scan play on while the repeat play range is set to “**Disc**”, scan play is performed for only the first tracks of each folder.

④ Uses “Sound Retriever” function

“**Sound Retriever**” function automatically enhances compressed audio and restores rich sound.

Each touch of [**Sound Retriever**] changes the setting as follows:

- **MODE 1:** Activates “**Sound Retriever**” function.
 - **MODE 2:** Activates “**Sound Retriever**” function.
 - **Off:** Deactivates “**Sound Retriever**” function.
- MODE 2** has a stronger effect than **MODE 1** and is more effective when playing back highly compressed audio data. 

Playing a DVD-Video

You can play a DVD Video using the built in drive of the navigation system. This section describes operations for playing a DVD Video.

Starting procedure

1 Display the AV operation screen.

- ➔ For details of the operations, refer to *Displaying the AV operation screen* on page 77.

2 Insert the disc you want to play into disc-loading slot.

The source changes and then playback will start.

- ➔ For details of the operation, refer to *Inserting and ejecting a disc* on page 14.
- If the disc is already set, tap [Disc] on the left edge of the screen.
- ➔ For details, refer to *Selecting a source* on page 77.

3 Use the touch panel keys on the screen to control the disc.

- ➔ For details, refer to *Using the touch panel keys* on the next page. □

- Shows the current audio channel type, such as "Mch" (Multi channel).
- ⑤ **Subtitle number indicator**
Shows the subtitle number currently selected.
- ⑥ **Subtitle language indicator**
Shows the subtitle language currently selected.
- ⑦ **Viewing angle indicator**
Shows what viewing angle has been selected.
- ⑧ **Current time**
- ⑨ **Digital sound format indicator**
Shows which digital sound format (surround sound format) has been selected.
- ⑩ **Play time indicator**
Shows the elapsed playing time within the current title.
- ⑪ **Source icon**
Shows which source has been selected. □

Reading the screen

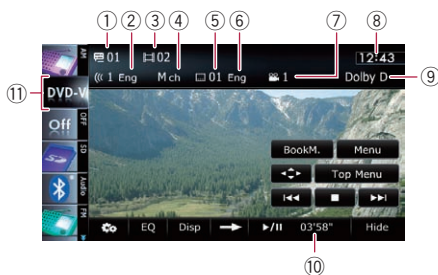

- ① **Title number indicator**
Shows the title number currently playing.
- ② **Audio track indicator**
Shows the audio track number and audio language currently selected.
- ③ **Chapter number indicator**
Shows the chapter number currently playing.
- ④ **Audio channel indicator**

Using the touch panel keys

Playback screen (page 1)

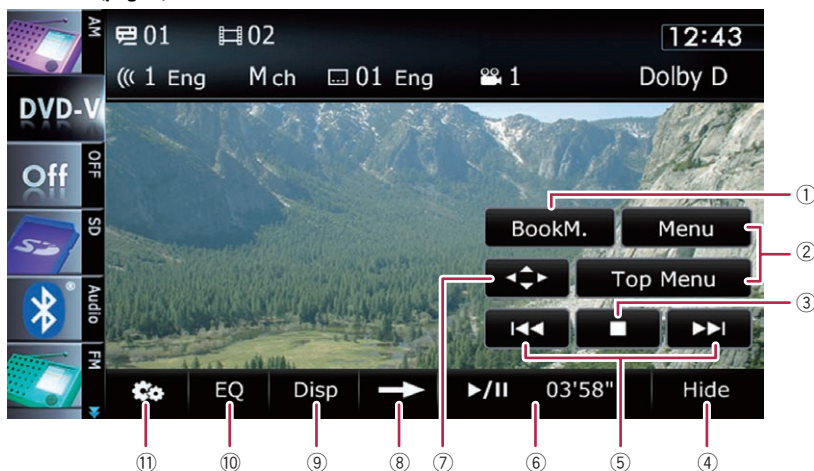

Playback screen (page 2)



Playback screen (page 3)

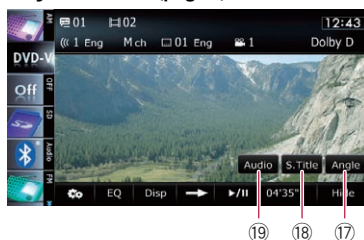

- ❑ With some discs, the icon  may be displayed, meaning that the operation is invalid.

① Resumes playback (Bookmark)

➔ For details, refer to *Resuming playback (Bookmark)* on the next page.

② Displays the DVD menu

You can display the menu by touching [**Menu**] or [**Top Menu**] while a disc is playing. Touching either of these keys again lets you start playback from the location selected from the menu. For details, refer to the instructions provided with the disc.

③ Stops playback

④ Hides the touch panel keys and information of the current video

Touching [**Hide**] shows only the current video. To display the touch panel keys and information of the current video, touch the screen.

⑤ Skips forward or backward

Touching [**▶▶▶**] skips to the start of the next chapter. Touching [**◀◀◀**] once skips to the start of the current chapter. Touching it twice quickly will skip to the previous chapter.

- ❑ You can also perform these operations by using the **TRK** button.

⑥ Playback and Pause

Touching [**▶/||**] switches between playback and pause.

⑦ Displays the DVD menu keypad

➔ For details, refer to *Using DVD menu by touch panel keys* on page 100.

Playing a DVD-Video

- ⑧ **Switches to the next page of touch panel keys**
- ⑨ **Switches the display**
Touching [Disp] changes the indication on the information plate as follows:
Disc information display Repeat range and L/R select display
- ⑩ **Recalls equalizer curves**
➔ For details, refer to *Using the equalizer* on page 172.
- ⑪ **Displays the “Function” menu**
➔ For details, refer to *Using the “Function” menu* on page 101.
- ⑫ **Searches for a desired scene and starts playback from a specified time**
➔ For details, refer to *Searching for a specific scene and starting playback from a specified time* on the next page.
- ⑬ **Performs an operation (such as resuming) that is stored on the disc**
When using a DVD that has a point recorded that indicates where to return to, the DVD returns to the specified point and begins playback from that point.
- ⑭ **Skips the title forward or backward**
Touching [▶] skips to the start of the next title.
Touching [◀] skips to the start of the previous title.
- ⑮ **Fast reverse or forward**
Touch [◀◀] or [▶▶] to perform fast reverse or forward.
If you touch and hold [◀◀] or [▶▶] for five seconds, fast reverse/fast forward continues even if you release either of these keys. To resume playback at a desired point, touch [▶/||], [◀◀] or [▶▶] opposite to key pushed for five seconds.
- ⑯ **Frame-by-frame playback (or slow-motion playback)**
➔ For details, refer to *Frame by frame playback* on page 101.
➔ For details, refer to *Slow motion playback* on page 101.
- ⑰ **Changes the viewing angle (Multi-angle)**
Each touch of [Angle] switches between viewing angles.

- ❑ During playback of a scene shot from multiple angles, the angle icon  is displayed. Turn the angle icon display on or off using the “DVD/DivX® Setup” menu.
➔ For details, refer to *Setting the angle icon display* on page 107.
- ⑱ **Changes the subtitle (Multi-subtitle)**
Each touch of [S.Title] switches between the subtitle languages recorded on the disc.
- ⑲ **Changes the audio track (Multi-audio)**
Each touch of [Audio] switches between audio tracks recorded in the disc.
❑ DTS audio format cannot be output, so select an audio track other than DTS audio format.
❑ Display indications such as **MPEG-A** and **Mch** describe the audio track recorded on the DVD. This indication may not be the same as the actual sound currently output from the navigation system.

Resuming playback (Bookmark)

The Bookmark function lets you resume playback from a selected scene the next time the disc is loaded.

● Touch [BookM.].



You can bookmark one point for each of up to five discs. If you try to memorize another point for the same disc, the oldest bookmark will be overwritten by the newer one.

- ❑ To clear the bookmark on a disc, touch and hold [BookM.].

Searching for a specific scene and starting playback from a specified time

You can search for the scene you want by specifying a title or a chapter, and the time.

- ❑ Chapter search and time search are not available when disc playback has been stopped.

1 Touch [Search] and then touch [Title] (title), [Chapter] (chapter), [Time] (time).

2 Touch the keys to input the target number or time and then touch [Enter].

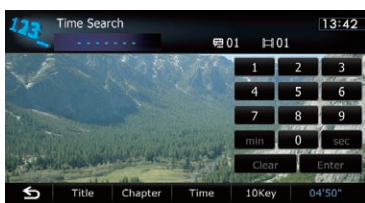

For titles, chapters

- To select 3, touch [3] and [Enter] in order.
- To select 10, touch [1] and [0] and [Enter] in order.

For time (time search)

- To select 5 minutes 3 seconds, touch [5], [min], [3], [sec] and [Enter] in order.
- To select 71 minutes 00 seconds, touch [7], [1], [min] and [Enter] in order.
- To select 100 minutes 05 seconds, touch [1], [0], [0], [5], [sec] and [Enter] in order.
- ❑ To cancel an input number, touch [Clear]. To cancel the input numbers, touch and hold [Clear].

Direct number search

You can use this function when you need to enter a numerical command during DVD playback.

1 Touch [Search].



2 Touch [10Key].

3 Touch [0] to [9] to input the desired number.

4 While the input number is displayed, touch [Enter].

Operating the DVD menu

You can operate the DVD menu by touching the menu item on the screen directly.

- ❑ This function can be used when the  key is displayed on the lower right corner of the LCD screen.
- ❑ This function may not work properly with some DVD disc content. In that case, use touch panel keys to operate the DVD menu.
- ❑ If you touch the screen while  is displayed, the touch panel keys will not be displayed.

1 Touch the screen to display the touch panel keys.

2 Touch [Top Menu] or [Menu] to display touch panel keys to operate the DVD menu.

3 Touch the desired menu item.

- Touch .

The touch panel keys to select the menu item are displayed.

Using DVD menu by touch panel keys

If items on the DVD menu appear, the touch panel keys may overlay them. If so, select an item using those touch panel keys.

Playing a DVD-Video

1 Touch [▲], [▼], [◀] or [▶] to select the desired menu item.

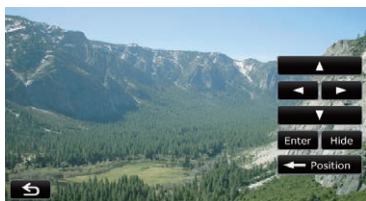

- If the touch panel keys for DVD menu selection disappear, touching anywhere on the screen, then touching  displays them again.

2 Touch [Enter].

Playback starts from the selected menu item. The way to display the menu differs depending on the disc.

- Touch [Position].

Each touch of [Position] changes the display position of touch panel keys.

- Touch [Hide].

The touch panel keys are hidden.

And  is displayed, so you can select a menu item by touching the screen.

Frame-by-frame playback

This lets you move ahead one frame at a time during pause.

● Touch [⏮] during pause.

Each time you touch [⏮], you move ahead one frame.

- To return to normal playback, touch [▶/⏮].
- With some discs, images may be unclear during frame by frame playback.

Slow motion playback

This lets you slow down playback speed.

1 Touch and hold [⏮] until ⏮ is displayed during playback.

The icon ⏮ is displayed, and forward slow motion playback begins.

- To return to normal playback, touch [▶/⏮].

2 Touch [⏮] or [⏭] to adjust playback speed during slow motion playback.

Each time you touch [⏮] or [⏭] it changes the speed in four steps in the following order:

1/16 ↔ 1/8 ↔ 1/4 ↔ 1/2

- There is no sound during slow motion playback.
- With some discs, images may be unclear during slow motion playback.
- Reversed slow motion playback is not possible. 

Using the “Function” menu

● Touch on the “DVD-V” screen.

The “Function” menu appears.

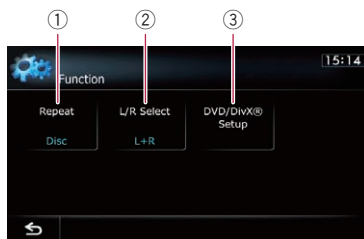

① Changes the repeat range

Each touch of [Repeat] changes the setting as follows:

- **Disc:** Plays throughout the current disc.
- **Chapter:** Repeats just the current chapter.
- **Title:** Repeats just the current title.

- If you perform chapter (title) search, fast forward, fast reverse or slow motion playback, the repeat play range changes to “Disc”.

- This function is not available when disc playback has been stopped.

② Selects audio output

When playing DVDs recorded with LPCM audio, you can switch the audio output.

Touch [L/R Select] repeatedly until the desired audio output appears on the display.

Each touch of [**L/R Select**] changes the settings as follows:

- **L+R**: Left and right
 - **L**: Left
 - **R**: Right
 - **Mix**: Mixing left and right
- This function is not available when disc playback has been stopped.

③ **DVD setup adjustments**

- ➔ For details, refer to *Displaying DVD/DivX® Setup menu* on page 107.

Playing a DivX video

You can play a DivX disc using the built in drive of the navigation system. This section describes those operations.

Starting procedure

1 Display the AV operation screen.

- For details of the operations, refer to *Displaying the AV operation screen* on page 77.

2 Insert the disc you want to play into disc-loading slot.

The source changes and then playback will start.

- For details of the operation, refer to *Inserting and ejecting a disc* on page 14.
- If the disc is already set, tap **[Disc]** on the left edge of the screen.
- For details, refer to **Selecting a source** on page 77.

3 Use the touch panel keys on the screen to control the disc.

- For details, refer to *Using the touch panel keys* on the next page. ■

④ Audio channel indicator

Shows the current audio channel type, such as “Mch” (Multi channel).

⑤ Subtitle number indicator

Shows the subtitle number currently selected.

⑥ Repeat range indicator

Shows which repeat range has been selected.

- For details, refer to **Changes the repeat range** on page 106.

⑦ Current time

⑧ Digital sound format indicator

Shows the digital sound format (surround sound format) currently selected.

⑨ Play time indicator

Shows the elapsed playing time within the current file.

⑩ Source icon

Shows which source has been selected. ■

Reading the screen



① Folder number indicator

Shows the folder number currently playing.

② Audio track indicator

Shows the audio track number currently selected.

③ File number indicator

Shows the file number currently playing.

Using the touch panel keys

Playback screen (page 1)

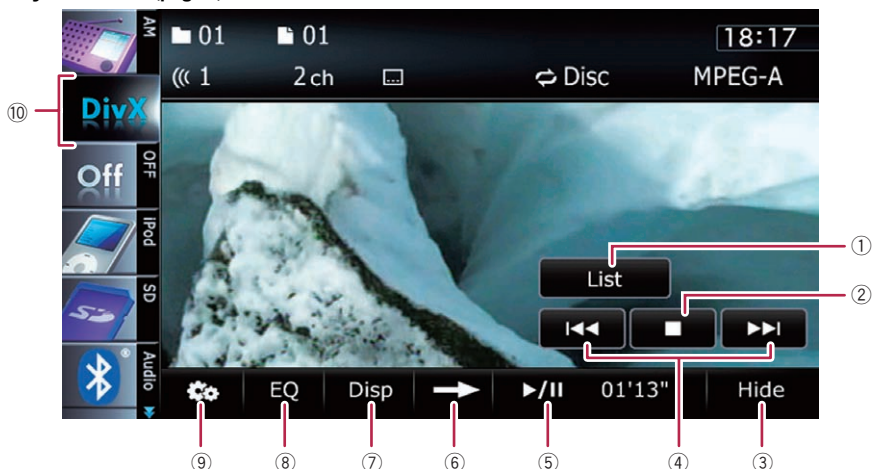

Playback screen (page 2)



- ❑ With some discs, the icon  may be displayed, meaning that the operation is invalid.

① Selects a file from the list

Touching the key displays the list which lets you see the list of file names or folder names on a disc.

- ❑ A dash () is displayed if there is no corresponding information.

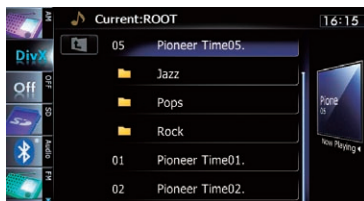

Tapping a folder on the list shows its content. You can play a file on the list by tapping it.



➔ For details, refer to *Operating list screens* (e.g. *iPod list screen*) on page 77.

The contents of the folder in which the currently playing file is located are displayed.

Playing a DivX video

Touching  displays the content of the upper folder (parent folder). If the uppermost folder is listed,  cannot be used.

② **Stops playback**

③ **Hides the touch panel keys and information of the current video**

Touching [**Hide**] shows only the current video. To display the touch panel keys and information of the current video, touch the screen.

④ **Skips forward or backward**

Touching [**▶▶**] skips to the start of the next file. Touching [**◀◀**] once skips to the start of the current file. Touching it twice quickly will skip to the previous file.

You can also perform these operations by using the **TRK** button.

⑤ **Playback and Pause**

Touching [**▶/||**] switches between playback and pause.

⑥ **Switches to the next page of touch panel keys**

⑦ **Switches the information**

Touching [**Disp**] changes the content of the information panel as follows:

Disc information display Current folder name display Current file name display

⑧ **Recalls equalizer curves**

➔ For details, refer to *Using the equalizer* on page 172.

⑨ **Displays the “Function” menu**

➔ For details, refer to *Using the “Function” menu* on the next page.

⑩ **Switches the media file type played**

When playing a disc containing a mixture of various media file types, you can switch between media file types to play.

Tap the key repeatedly to switch between the following media file types:

CD (audio data (CD DA)) **ROM** (compressed audio file) **DivX** (DivX video files)

⑪ **Searches for a desired scene and starts playback from a specified time**

➔ For details, refer to *Starting playback from a specified time* on the next page.

⑫ **Changes audio tracks (Multi-audio)**

Each touch of [**Audio**] switches between audio tracks.

⑬ **Changes the subtitle (Multi-subtitle)**

Each touch of [**S.Title**] switches between the subtitle languages recorded on the disc.

⑭ **Fast reverse or forward**

Touch [**◀◀**] or [**▶▶**] to perform fast reverse or forward.

If you touch and hold [**◀◀**] or [**▶▶**] for five seconds, fast reverse/fast forward continues even if you release either of these keys. To resume playback at a desired point, touch [**▶/||**], [**◀◀**] or [**▶▶**] opposite to key pushed for five seconds.

⑮ **Frame-by-frame playback (or slow-motion playback)**

➔ For details, refer to *Frame by frame playback* on this page.

➔ For details, refer to *Slow motion playback* on this page.

Frame-by-frame playback

This lets you move ahead one frame at a time during pause.

● **Touch [**||▶**] during pause.**

Each time you touch [**||▶**], you move ahead one frame.

- To return to normal playback, touch [**▶/||**].
- With some discs, images may be unclear during frame by frame playback.

Slow motion playback

This lets you slow down playback speed.

● **Touch and hold [**||▶**] until **||▶** is displayed during playback.**

The icon **||▶** is displayed, and forward slow motion playback begins.

- To return to normal playback, touch [**▶▶**] or [**◀◀**], etc.
- There is no sound during slow motion playback.
- With some discs, images may be unclear during slow motion playback.
- Reversed slow motion playback is not possible.

Starting playback from a specified time

You can search for a desired scene by specifying the time.

- Time search are not possible when disc playback has been stopped.

1 Touch [Search].

2 Touch the keys to input the target number or time and then touch [Enter].

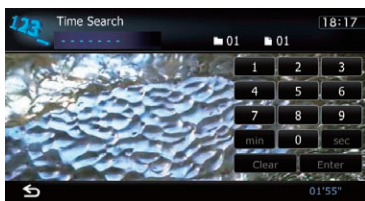

- To select 5 minutes 3 seconds, touch [5], [min], [3], [sec] and [Enter] in order.
- To select 71 minutes 00 seconds, touch [7], [1], [min] and [Enter] in order.
- To select 100 minutes 05 seconds, touch [1], [0], [0], [5], [sec] and [Enter] in order.
- To cancel an input number, touch [Clear]. To cancel the input numbers, touch and hold [Clear].

- **Disc:** Plays throughout the current disc.
- **File:** Repeats just the current file.
- **Folder:** Repeats just the current folder.
- If you select another folder during repeat play, the repeat play range changes to "Disc".
- If you perform fast reverse or fast forward during "File", the repeat play range changes to "Folder".
- When "Folder" is selected, it is not possible to playback a subfolder of that folder.
- When playing discs with compressed audio files and audio data (CD DA), repeat play is performed within DivX videos even if "Disc" is selected.

② DVD setup adjustments

- ➔ For details, refer to *Displaying DVD/DivX® Setup menu* on the next page.

Using the "Function" menu

- Touch  on the "DivX" screen.

The "Function" menu appears.

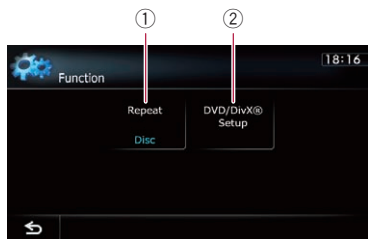

① Changes the repeat range

Each touch of [Repeat] changes the setting as follows:

DVD-Video or DivX setup

This chapter describes how to configure the DVD Video/DivX player.

Displaying DVD/DivX® Setup menu

1 Play the disc that contains DVD-Video or DivX.

2 Display the AV operation screen.

- For details of the operations, refer to *Displaying the AV operation screen* on page 77.

3 Touch .

The “Function” menu appears.

4 Touch [DVD/DivX® Setup].

The “DVD/DivX® Setup” screen appears.

5 Touch the desired function.



Setting the top-priority languages

You can assign the top priority language to the top priority subtitle, audio and menu in initial playback. If the selected language is recorded on the disc, subtitles, audio and menu are displayed or output in that language.

1 Display the “DVD/DivX® Setup” screen.

- For details, refer to *Displaying DVD/DivX® Setup menu* on this page.

2 Touch [Subtitle Language], [Audio Language] or [Menu Language].

Each language menu is displayed and the currently set language is selected.

3 Touch the desired language.

When you select “Others”, a language code input display is shown. Input the four digit code of the desired language then touch [Enter].

- For details, refer to *Language code chart for DVDs* on page 110.
- ❑ If the selected language is not recorded on the disc, the default language specified on the disc is output and displayed.
- ❑ You can also switch the subtitle and audio language by touching [S.Title] or [Audio] during playback.
- ❑ Even if you use “S.Title” or “Audio” to switch the subtitle or audio language, this does not affect the settings here. 

Setting the angle icon display

You can set the angle icon  to display in scenes where the angle can be switched.

1 Display the “DVD/DivX® Setup” screen.

- For details, refer to *Displaying DVD/DivX® Setup menu* on this page.

2 Touch [Multi Angle].

Touching [Multi Angle] switches between “On” and “Off”. 

Setting the aspect ratio

There are two kinds of displays. A wide screen display has a width to height ratio (TV aspect) of 16:9, while a regular display has a TV aspect of 4:3. If you use a regular rear display with a TV aspect of 4:3, you can set the aspect ratio suitable for your rear display. (We recommend use of this function only when you want to fit it to the rear display.)

DVD-Video or DivX setup



- ❑ When using a regular display, select either “**Letter Box**” or “**Panscan**”. Selecting “**16:9**” may result in an unnatural picture.

1 Display the “DVD/DivX® Setup” screen.

- ➔ For details, refer to *Displaying DVD/DivX® Setup menu* on the previous page.

2 Touch [TV Aspect].

Each touch of [TV Aspect] changes the setting as follows:

- **16:9**: Wide screen picture (16:9) is displayed as it is (initial setting).
- **Letter Box**: The picture is in the shape of a letter box with black bands at the top and bottom of the screen.
- **Panscan**: The picture is cut short at the right and left of the screen.
- ❑ When playing discs that do not have a pan scan system, the disc is played back with “**Letter Box**” even if you select “**Panscan**” setting. Confirm whether the disc package bears the  mark.
- ❑ Some discs do not enable changing of the TV aspect. For details, refer to the disc’s instructions. 

Setting the parental lock

Some DVD Video discs let you use parental lock to set restrictions so that children cannot watch violent or adult oriented scenes. You can set the parental lock level in steps as de sired.

- ❑ When you set a parental lock level and then play a disc featuring parental lock, code number input indications may be displayed. In this case, playback will begin when the correct code number is input.

Setting the code number and level

When you first use this function, register your code number. If you do not register a code number, parental lock will not operate.

1 Display the “DVD/DivX® Setup” screen.

- ➔ For details, refer to *Displaying DVD/DivX® Setup menu* on the previous page.

2 Touch [Parental Level].



3 Touch [0] to [9] to input a four-digit code number.

4 While the input number is displayed, touch [Enter].

The code number is registered, and you can now set the level.

5 Touch any of [1] to [8] to select the desired level.

The parental lock level is set.

- **Level 8**: Playback of the entire disc is possible (initial setting).
- **Level 7 to Level 2**: Playback of discs for children and non adult oriented discs is possible.
- **Level 1**: Only playback of discs for children is possible.
- ❑ If you want to change the parental level already set, enter the registered code number and then select the parental level.
- ❑ We recommend that you keep a record of your code number in case you forget it.
- ❑ The parental lock level is recorded on the disc. You can confirm it by looking at the disc package, the included literature or the disc itself. You cannot use parental lock with discs that do not feature a recorded parental lock level.
- ❑ With some discs, parental lock operates to skip certain scenes only, after which normal playback resumes. For details, refer to the disc’s instructions.
- ❑ If you forget the registered code number, touch  10 times on the number input screen. The registered code number is canceled, letting you register a new one. 

DVD-Video or DivX setup

Setting the auto play

When a DVD disc with DVD menu is inserted, this unit will cancel the DVD menu automatically and start playback from the first chapter of the first title.

- ❑ This function is available for DVD Video.
- ❑ Some DVDs may not operate properly. If this function is not fully operable, turn this function off and start playback.

1 Display the "DVD/DivX® Setup" screen.

- ➔ For details, refer to *Displaying DVD/DivX® Setup menu* on page 107.

2 Touch [Auto Play].

Touching [Auto Play] switches this setting between "On" and "Off".

- ❑ When "Auto Play" is set to "On", the repeat range is automatically set to "Disc".

Setting the subtitle file for DivX

You can select whether to display DivX external subtitles or not.

- ❑ If no DivX external subtitle files exist, the original DivX subtitles are displayed even when "Custom" is selected.

1 Display the "DVD/DivX® Setup" screen.

- ➔ For details, refer to *Displaying DVD/DivX® Setup menu* on page 107.

2 Touch [Subtitle File].

Touching [Subtitle File] switches this setting between "Original" and "Custom".

- ❑ Up to 42 characters can be displayed on one line. If more than 42 characters are set, the line breaks and the characters are displayed on the next line.
- ❑ Up to 126 characters can be displayed on one screen. If more than 126 characters are set, the excess characters will not be displayed.

- ❑ The DivX subtitles will be displayed even when the subtitle file setting is on if no corresponding subtitle files exist.
- ❑ Up to three lines can be displayed at once.

Language code chart for DVDs

Two-letter code, input code	Language	Two-letter code, input code	Language	Two-letter code, input code	Language
aa, 0101	Afar	ia, 0901	Interlingua	rn, 1814	Rundi
ab, 0102	Abkhazian	ie, 0905	Interlingue	ro, 1815	Romanian
af, 0106	Afrikaans	ik, 0911	Inupiaq	ru, 1821	Russian
am, 0113	Amharic	in, 0914	Indonesian	rw, 1823	Kinyarwanda
ar, 0118	Arabic	is, 0919	Icelandic	sa, 1901	Sanskrit
as, 0119	Assamese	it, 0920	Italian	sd, 1904	Sindhi
ay, 0125	Aymara	ja, 1001	Japanese	sg, 1907	Sango
az, 0126	Azerbaijani	ji, 1009	Yiddish	sh, 1908	Serbo Croatian
ba, 0201	Bashkir	jw, 1023	Javanese	si, 1909	Sinhala
be, 0205	Belarusian	ka, 1101	Georgian	sk, 1911	Slovak
bg, 0207	Bulgarian	kk, 1111	Kazakh	sl, 1912	Slovenian
bh, 0208	Bihari	kl, 1112	Kalaallisut	sm, 1913	Samoan
bi, 0209	Bislama	km, 1113	Central Khmer	sn, 1914	Shona
bn, 0214	Bengali	kn, 1114	Kannada	so, 1915	Somali
bo, 0215	Tibetan	ko, 1115	Korean	sq, 1917	Albanian
br, 0218	Breton	ks, 1119	Kashmiri	sr, 1918	Serbian
ca, 0301	Catalan	ku, 1121	Kurdish	ss, 1919	Swati
co, 0315	Corsican	ky, 1125	Kirghiz; Kyrgyz	st, 1920	Sotho, Southern
cs, 0319	Czech	la, 1201	Latin	su, 1921	Sundanese
cy, 0325	Welsh	ln, 1214	Lingala	sv, 1922	Swedish
da, 0401	Danish	lo, 1215	Lao	sw, 1923	Swahili
de, 0405	German	lt, 1220	Lithuanian	ta, 2001	Tamil
dz, 0426	Dzongkha	lv, 1222	Latvian	te, 2005	Telugu
ee, 0505	Ewe	mg, 1307	Malagasy	tg, 2007	Tajik
el, 0512	Greek	mi, 1309	Maori	th, 2008	Thai
en, 0514	English	mk, 1311	Macedonian	ti, 2009	Tigrinya
eo, 0515	Esperanto	ml, 1312	Malayalam	tk, 2011	Turkmen
es, 0519	Spanish	mn, 1314	Mongolian	tl, 2012	Tagalog
et, 0520	Estonian	mo, 1315	Moldavian	tn, 2014	Tswana
eu, 0521	Basque	mr, 1318	Marathi	to, 2015	Tonga
fa, 0601	Persian	ms, 1319	Malay	tr, 2018	Turkish
fi, 0609	Finnish	mt, 1320	Maltese	ts, 2019	Tsonga
fj, 0610	Fijian	my, 1325	Burmese	tt, 2020	Tatar
fo, 0615	Faroese	na, 1401	Nauru	tw, 2023	Twi
fr, 0618	French	ne, 1405	Nepali	uk, 2111	Ukrainian
fy, 0625	Western Frisian	nl, 1412	Dutch; Flemish	ur, 2118	Urdu
ga, 0701	Irish	no, 1415	Norwegian	uz, 2126	Uzbek
gd, 0704	Gaelic	oc, 1503	Occitan	vi, 2209	Vietnamese
gl, 0712	Galician	om, 1513	Oromo	vo, 2215	Volapuk
gn, 0714	Guarani	or, 1518	Oriya	wo, 2315	Wolof
gu, 0721	Gujarati	pa, 1601	Panjabi; Punjabi	xh, 2408	Xhosa
ha, 0801	Hausa	pl, 1612	Polish	yo, 2515	Yoruba
hi, 0809	Hindi	ps, 1619	Pushto; Pashto	zh, 2608	Chinese
hr, 0818	Croatian	pt, 1620	Portuguese	zu, 2621	Zulu
hu, 0821	Hungarian	qu, 1721	Quechua		
hy, 0825	Armenian	rm, 1813	Romansh		



Playing music files (from USB or SD)

You can play the compressed audio files stored in the external storage device (USB, SD).

- ❑ In the following description, the SD memory card and USB memory device are collectively referred to as the “external storage device (USB, SD)”. If it indicates the USB memory device only, it is referred to as the “USB storage device”.

Starting procedure

1 Display the AV operation screen.

- ➡ For details of the operations, refer to *Displaying the AV operation screen* on page 77.

2 Insert the SD memory card into the SD card slot or plug the USB storage device into the USB connector.

- ➡ For details, refer to *Plugging in a USB storage device* on page 18.
- ➡ For details, refer to *Inserting and ejecting an SD memory card* on page 15.

- ❑ Playback is performed in order of folder numbers. Folders are skipped if they contain no playable files. If there are no playable files in folder 01 (root folder), playback starts from folder 02.

3 Tap [USB] or [SD] on the left edge of the screen to display the “USB” or “SD” screen.

4 Use the touch panel keys on the screen to control the external storage device (USB, SD).

- ➡ For details, refer to *Using the touch panel keys (Music)* on page 113. ■

Reading the screen

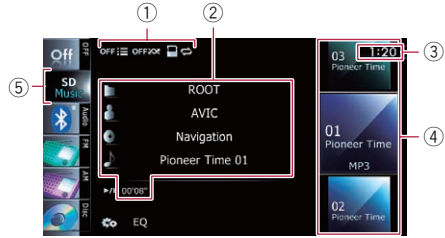

- ❑ This unit may not achieve optimum performance with some external storage devices.
- ❑ You can playback the files on a USB storage device compliant with Mass Storage Class. For details about the USB Class, refer to the manual supplied with the USB storage device.

① Playback condition indicator

Indicates the current playback condition.



- Scanning folders and files

Indicator:	Meaning
	Cancels the scan play.
	Plays the first audio files of each folder for about 10 seconds when the repeat range is set to "Media".
	Plays the beginning of each audio file in the current folder for about 10 seconds when the repeat range is set to "Folder".





- Playing files in random order

Indicator:	Meaning
	Does not play files in random order.
	Plays all audio files in the current repeat play range in random order.

- Setting a repeat play range

Indicator:	Meaning
	Repeats all compressed audio files in the selected external storage device (USB, SD).
	Repeats just the current file.
	Repeats the current folder.

② Current file information

-  **Folder name**
Shows the folder name currently playing.
-  **Artist name**
Shows the artist name currently playing (when available).
-  **Album title**
Shows the title of the album for the current file (when available).
-  **Track title**
Shows the title of the track currently playing (when available).
 If the title of a track is not available, the file name appears.
- **Play time**
Shows the elapsed playing time within the current file.
 "-----" is displayed if there is no corresponding information.

③ Current time

④ File information

- **File number indicator**
- **File name indicator**
- **File type indicator**
Shows the type of audio file.

⑤ Source icon

Shows which source has been selected. 

Playing music files (from USB or SD)

Using the touch panel keys (Music)

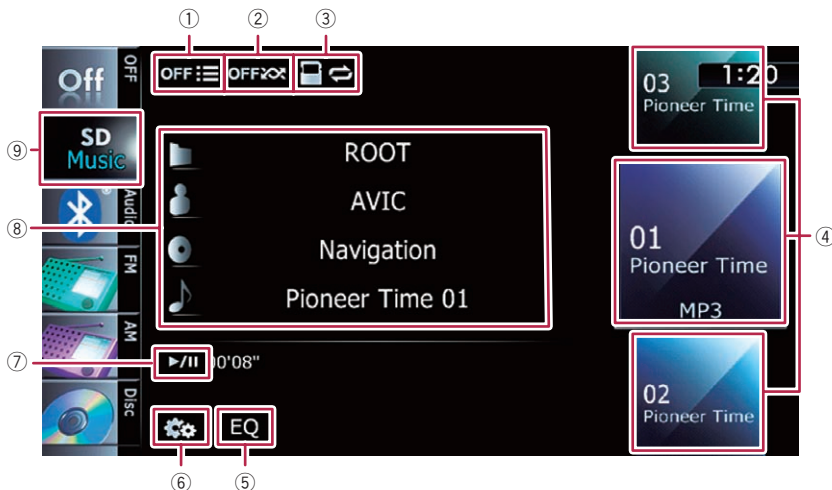

- ① **Scans folders and files**
Scan play is performed by touching only one key.
➔ For details of the operation, refer to **Scans folders and files** on the next page.
- ② **Plays files in random order**
The files in the current repeat play range can be played at random by touching only one key.
➔ For details of the operation, refer to **Plays files in random order** on the next page.
- ③ **Sets a repeat play range**
The repeat play range can be changed by touching only one key.
➔ For details, refer to **Changes the repeat range** on the next page.
- ④ **Selects a file to play**
Scrolling the keys up or down displays files, and tapping a file starts playback. Tapping the lower key during random play back skips to the next file. Tapping the upper key jumps to the start of the current file.
- ⑤ **Recalls equalizer curves**
➔ For details, refer to *Using the equalizer* on page 172.
- ⑥ **Displays the "Function" menu**

- ➔ For details, refer to *Using the "Function" menu* on the next page.
- ⑦ **Playback and Pause**
Touching [▶/||] switches between playback and pause.
- ⑧ **Selects a file from the list**
Touching the key displays the list which lets you see the list of track titles or folder names on an external storage device (USB, SD). Tapping a folder on the list shows its content. You can play a file on the list by tapping it.

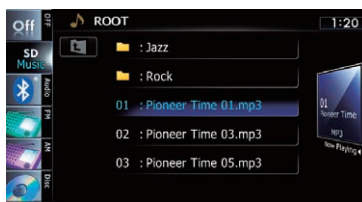

- ➔ For details, refer to *Operating list screens (e.g. iPod list screen)* on page 77.
- Touching [📁] displays the content of the upper folder (parent folder). If the uppermost folder is listed, [📁] cannot be used.
- ⑨ **Switches the operation screen**

Tapping this key switches between the screen to operate music files and the screen to operate video files. This touch panel key is available only when there are both audio and video files in the external storage device (USB, SD).

Using the “Function” menu

- Touch  on the “USB” or “SD” screen.

The “Function” menu appears.



① Changes the repeat range

Each touch of [**Repeat**] changes the setting as follows:

- **Media:** Repeats all compressed audio files in the selected external storage device (USB, SD).
 - **Track:** Repeats just the current file.
 - **Folder:** Repeats the current folder.
- If you skip the file forward or backward when the repeat play range in “Track”, the repeat play range changes to “Folder”.

② Plays files in random order

Random play lets you playback files in random order within the current repeat range. Each touch of [**Random**] turns it on or off.

- If you turn the random play on when the repeat play range is set to “Track”, the repeat play range changes to “Folder” automatically.

③ Scans folders and files

Scan play lets you hear the first 10 seconds of each file. Scan play is performed in the current repeat play range.

Each touch of [**Scan**] turns it on or off.

When you find the track you want, touch [**Scan**] to turn the scan play off.

- After all files or folders scanning are finished, normal playback will begin again.
- If you turn the scan play on when the repeat play range is set to “Track”, the repeat play range changes to “Folder” automatically.

Playing video files (from USB or SD)

You can play the video files stored in the external storage device (USB, SD).

- In the following description, the SD memory card and USB memory device are collectively referred to as the “external storage device (USB, SD)”. If it indicates the USB memory device only, it is referred to as the “USB storage device”.

Starting procedure

1 Display the AV operation screen.

- ➔ For details of the operations, refer to *Displaying the AV operation screen* on page 77.

2 Insert the SD memory card into the SD card slot or plug the USB storage device into the USB connector.

- ➔ For details, refer to *Plugging in a USB storage device* on page 18.
- ➔ For details, refer to *Inserting and ejecting an SD memory card* on page 15.
- Playback is performed in order of folder numbers. Folders are skipped if they contain no playable files. If there are no playable files in folder 01 (root folder), playback starts from folder 02.

3 Tap [USB] or [SD] on the left edge of the screen to display the “USB” or “SD” screen.

4 Touch the screen to display the touch panel keys.

5 Use the touch panel keys on the screen to control the external storage device (USB, SD).

- ➔ For details, refer to *Using the touch panel keys (Video)* on the next page.

Reading the screen

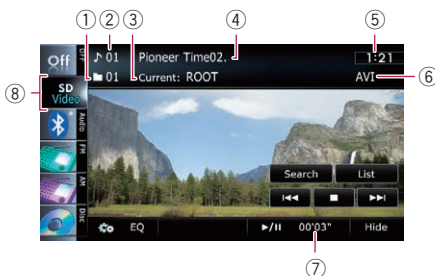

- This unit may not achieve optimum performance with some external storage devices.
- You can playback the files on a USB storage device compliant with Mass Storage Class. For details about the USB Class, refer to the manual supplied with the USB storage device.

① Folder number indicator

② File number indicator

③ Current folder name indicator

Shows the folder name currently playing.

④ File name indicator

Shows the file name currently playing.

⑤ Current time

⑥ File type indicator

Shows the type of audio file currently playing.

⑦ Play time indicator

Shows the elapsed playing time within the current file.

⑧ Source icon

Shows which source has been selected.

Using the touch panel keys (Video)

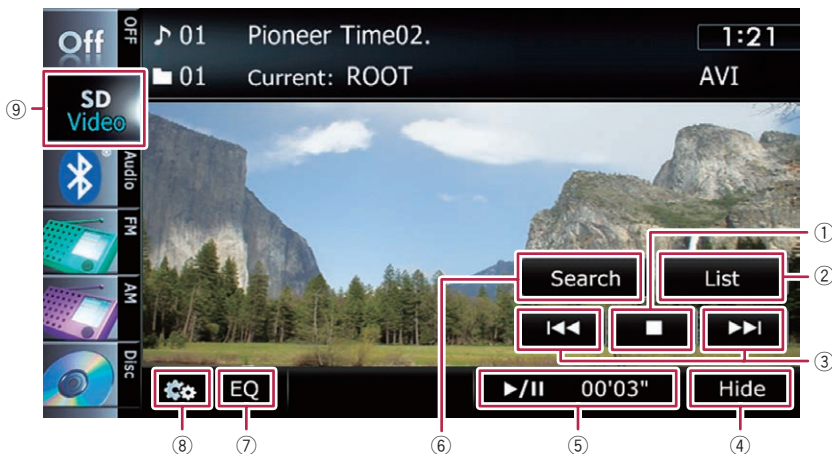



① Stops playback

② Selects a file from the list

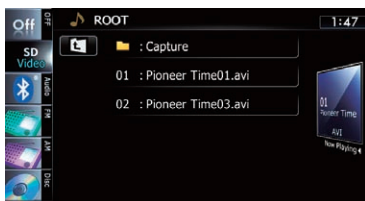

You can select and play the title you want from the list.





➔ For details, refer to *Operating list screens* (e.g. iPod list screen) on page 77.

The contents of the folder in which the currently playing file is located are displayed. Touching  displays the content of the upper folder (parent folder). If the uppermost folder is listed,  cannot be used.

③ Skips forward or backward

Touching  skips to the start of the next file. Touching  once skips to the start of the current file. Touching it twice quickly will skip to the previous file.

Fast reverse or forward

Touch and hold  or  to fast reverse or fast forward.

There is no sound on fast reverse or forward.

You can also perform these operations by using the **TRK** button.

④ Hides the touch panel keys and information of the current video

Touching  shows only the current video. To display the touch panel keys and information of the current video, touch the screen.

⑤ Playback and Pause

Touching  switches between playback and pause.

⑥ Searches for a desired scene and starts playback from a specified time

➔ For details, refer to *Searching for a specific scene and starting playback from a specified time* on the next page.

⑦ Recalls equalizer curves

➔ For details, refer to *Using the equalizer* on page 172.

⑧ Displays the “Function” menu

➔ For details, refer to *Using the “Function” menu* on the next page.

⑨ Switches the operation screen

Playing video files (from USB or SD)

Tapping this key switches between the screen to operate music files and the screen to operate video files. This touch panel key is available only when there are both audio and video files in the external storage device (USB, SD).

Searching for a specific scene and starting playback from a specified time

You can search for a desired scene by specifying the time.

1 Touch [Search].

2 Touch the keys to input the target number or time and then touch [Enter].

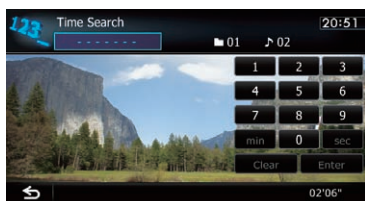

- To select 5 minutes 3 seconds, touch [5], [min], [3], [sec] and [Enter] in order.
- To select 71 minutes 00 seconds, touch [7], [1], [min] and [Enter] in order.
- To select 100 minutes 05 seconds, touch [1], [0], [0], [5], [sec] and [Enter] in order.
- To cancel an input number, touch [Clear].
To cancel the input numbers, touch and hold [Clear].

Using the “Function” menu

1 Tap [USB] or [SD] on the left edge of the screen to display the “USB” or “SD” screen.

- ➔ For details of the operations, refer to *Displaying the AV operation screen* on page 77.

2 Touch the screen to display the touch panel keys.

3 Touch .

The “Function” menu appears.

- If the touch panel keys are not shown, touch anywhere on the screen to display them.

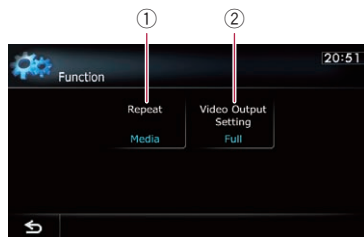

① Changes the repeat range

Each touch of [Repeat] changes the setting as follows:

- **Media:** Repeats all video files in the selected external storage device (USB, SD).
- **File:** Repeats just the current file.
- **Folder:** Repeats the current folder.
- If you skip the file forward or backward when the repeat play range in “File”, the repeat play range changes to “Folder”.

② Changes the screen size of video

If a video file is played, you can select the display mode between normal and full screen.

Each touch of [Video Output Setting] changes the setting as follows:

- **Normal:** Enlarges the display size while maintaining the aspect ratio.
- **Full:** Displays the image full screen although the aspect ratio may be affected.

Using the USB interface cable for iPod enables you to connect your iPod to the navigation system.

- A USB interface cable for iPod (CD IU50V) (sold separately) is required for connection.

Starting procedure

1 Display the AV operation screen.

- ⇒ For details of the operations, refer to *Dis playing the AV operation screen* on page 77.

2 Connect your iPod.

The source changes and then playback will start.

- ⇒ For details, refer to *Connecting your iPod* on page 19.
- If the iPod is already connected, tap **[iPod]** on the left edge of the screen.
- ⇒ For details, refer to **Selecting a source** on page 77.
- No video is output if iPod is selected as AV source, check the setting in **"AV1 Input"** on the **"AV System Settings"** menu.
- ⇒ For details, refer to *Setting video input 1 (AV1)* on page 168.

3 Use the touch panel keys on the screen to control your iPod.

- ⇒ For details of the operation, refer to *Using the touch panel keys* on page 120. □

Reading the screen

Music



Video

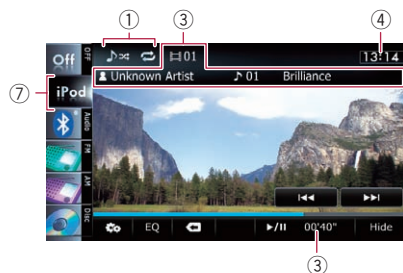

① Playback condition indicator

Indicates the current playback condition.

- Setting the shuffle play for music

Indicator:	Meaning
OFF	Cancels the shuffle play.
▶◀	Plays back songs in random order within the selected list.
⊙▶	Selects an album randomly, and then plays back all songs in that album in order.

- Setting a repeat play range

Indicator:	Meaning
⏮	Repeats all songs in the selected list.
⏮	Repeats just the current song.

② Current song (episode) information

- **[Artist icon]: Artist name (podcast title)**
Shows the artist name currently playing. When a podcast is played, the podcast title is displayed.
- **[Album icon]: Album title (release date)**
Shows the title of the album for the song. When a podcast is played, the release date is displayed.
- **[Song icon]: Song title (episode)**
Shows the title of the current song. When a podcast is played, the episode is displayed.
- **[Chapter icon]: Chapter number**

Using an iPod (iPod)

Shows the current chapter number and total number of chapters when the file with chapters played.

- **Play time**

Shows the elapsed playing time within the current song (episode).

- "-----" is displayed if there is no corresponding information.

③ Current video information

-  **Chapter number**

Shows the current chapter number when the video with chapters played.

-  **Artist name (podcast title)**

Shows the artist name currently playing. When a podcast is played, the podcast title is displayed.

-  **File number indicator**

Shows the number of the file currently playing.

- **File name indicator**

Shows the file name currently playing.

- **Play time indicator**

Shows the elapsed playing time within the current file.

④ Current time

⑤ Song (episode) information

- **Song number indicator**

Shows the number of the song and the total number of songs in the selected list.

- **Song title (episode) indicator**

- **Album artwork**

Album art of the current song is displayed if it is available.

⑥ Genre indicator

Shows the genre of the current song.

⑦ Source icon

Shows which source has been selected.

- If characters recorded on the iPod are not compatible with this navigation system, they may turn into garbled characters. □

Using the touch panel keys

Music

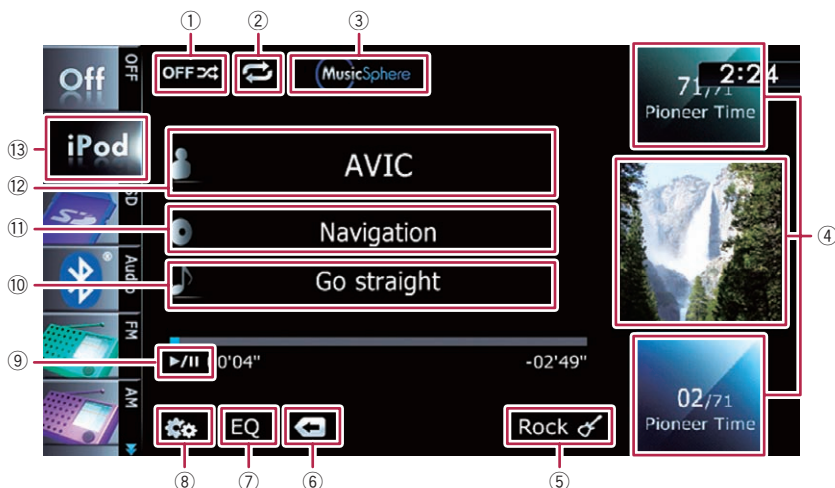

Video

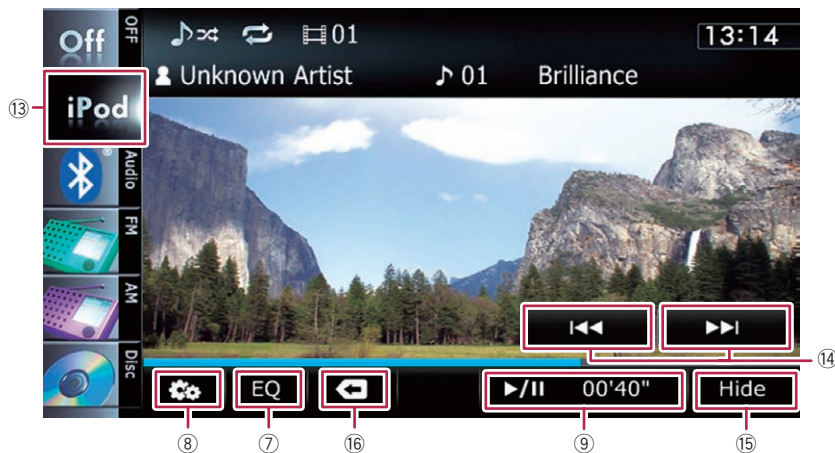

① **Sets the shuffle play for music**

The shuffle play setting can be changed by touching only one key.

➔ For details, refer to **Sets the shuffle play for music** on page 124.

② **Sets a repeat play range**

The repeat play range can be changed by touching only one key.

➔ For details, refer to **Sets repeat play** on page 124.

③ **Plays a playlist using MusicSphere**

Touching the key displays the **MusicSphere** screen, and a playlist created with the PC application (**MusicSphere**) can be played.

➔ For details, refer to **Playing MusicSphere** on page 124.

Using an iPod (iPod)

④ Selects a song to play

Scrolling the keys up or down displays songs, and tapping a song starts playback.

Tapping the lower key during shuffle playback skips to the next song. Tapping the upper key once skip to the start of the current song. Tapping it again will skip to the previous song. When the song with chapters played, chapter can be skipped back and forward.

⑤ Displays the genre list

⑥ Displays the top category menu

Touching the key displays the top category for song playback.

Displays the previous selected list

If you select the song from the list to play after touching , touching the key displays the previous list.

⑦ Recalls equalizer curves

➔ For details, refer to *Using the equalizer* on page 172.

⑧ Displays the “Function” menu

➔ For details, refer to *Using the “Function” menu* on page 124.

⑨ Playback and Pause

Touching  switches between playback and pause.

⑩ Displays the song list

⑪ Displays the album list

⑫ Displays the artist list

⑬ Switches the operation screen

Tapping this key displays the touch panel key (**[Video]** or **[Music]**) to switch between the screen to operate video files and the screen to operate music files.

➔ For details of the operation, refer to *Starting the video playback* on the next page.

❑ This touch panel key is available only when there are both audio and video file in your iPod.

❑ If iPod fifth generation is connected, the following settings are automatically changed when the operation screen is switched to the screen to operate video files.

- “Repeat” is set to “All”.
- “Shuffle” is set to “Off”.



- ❑ Touching **[Video]** or **[Music]** on the list screens enables you to perform the equivalent operation.





Displays the top category menu





Touching the key displays the top category menu for song or video playback.

⑭ Skips back or forward to another video

Touching  skips to the start of the next video. Touching  once skips to the start of the current video. Touching again will skip to the previous video. When the video with chapters played, chapter can be skipped back and forward.

Fast reverse or forward

Touch and hold  or  to fast reverse or fast forward.

If you touch and hold  or  for five seconds, fast reverse/fast forward continues even if you release either of these keys. To resume playback at a desired point, touch ,  or .

❑ You can also perform these operations by using the **TRK** button.



⑮ Hides the touch panel keys and information of the current video

Touching **[Hide]** shows only the current video. To display the touch panel keys and information of the current video, touch the screen.

⑯ Displays the top category menu for video

Touching the key displays the top category for video playback.

Displays the previous selected list

If you select the video from the list to play after touching , touching the key displays the previous list. 

Starting the video playback

This navigation system can play video if an iPod with video capabilities is connected.

1 Touch [iPod] on the left edge of the screen to display the touch panel key to switch to a video source.

2 Tap [Music].

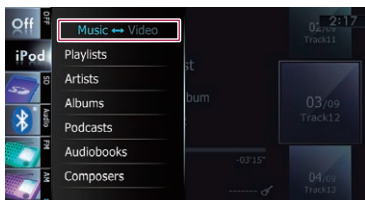

A list of videos by category appears.

3 Tap one of the categories in that contains the video you want to play.

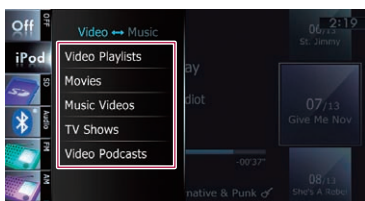

4 Tap your desired item on the list to narrow down them until the video list appears.

➔ For details, refer to *Narrowing down a song or video with the list* on this page.

5 On the video list, tap the video you want to play.

Video playback will start.

6 Touch the screen to display the touch panel keys.

➔ For details of the operation, refer to *Using the touch panel keys* on page 120. 

Narrowing down a song or video with the list

Tapping an item on list allows you to search for a song or video and play it in your iPod.

1 Display a list screen.

➔ For details, refer to *Displays the genre list* on the previous page.

➔ For details, refer to *Displays the song list* on the previous page.

➔ For details, refer to *Displays the album list* on the previous page.

➔ For details, refer to *Displays the artist list* on the previous page.

■ Touch  to display the top category menu screen, and then tap the category you want.

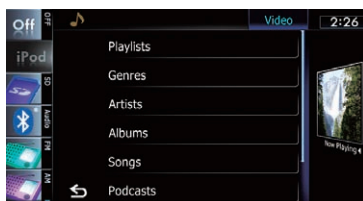

2 Scroll by dragging tabs up or down to display the character that you want to refine.

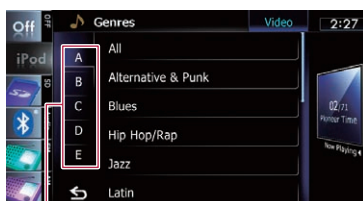

Alphabet tabs

3 Tap the tab to select the character and display the page which includes applicable options.

□ An article listed below and space at the beginning of the artist name will be ignored and the next character will be taken into account for searching.

"A" or "a"

Using an iPod (iPod)

"AN", "An", or "an"



"THE", "The", or "the"

4 Scroll by dragging items up or down, and display the item you want to select.

Refine the item until the song title (episode) is displayed on the list.

- ❑ Tapping **[All]** on the list includes all options in the current list. For example, if you tap **[All]** after tapping **[Artists]**, you can proceed to the next screen with all artists in the list selected.
- ❑ After you select **Artists, Albums, or Genres**, go on to tap one of the list to start playing the first song in the selected list and display the next hierarchy.

5 On the song (episode) or video list, tap the song (episode) or video you want to play.

- ❑ After you select the song (episode) or video using this function, touching  displays the list previously selected. 

Operating the functions from your iPod

You can control the functions by using iPod itself while iPod is connected to the navigation system. Sound can be heard from the car's speakers, and operation can be conducted from your iPod.

Even if "**Change Control Mode**" is set to "**iPod**", following functions are available from this navigation system.

- Playback and Pause
 - Fast reverse or forward
 - Skip forward or backward
 - Adjusting the volume
- ➞ For details, refer to **Sets iPod control mode** on page 125. 

Playing MusicSphere

You can play playlists created with the PC application (**MusicSphere**) using an exciting graphic interface.

- ❑ PC application (**MusicSphere**) will be available on our website.

Reading the screen



- 1 Playlist name indicator**
Shows the name of the playlist currently selected.
- 2 Current time**
- 3 Category name**
Shows the category name in the playlist.
- 4 Song title indicator**
Shows six songs including the first song played after selecting the playlist.
- 5 Category name and total number of songs**
Shows the category name and the total number of playable songs in the playlist currently selected.

Using the touch panel keys

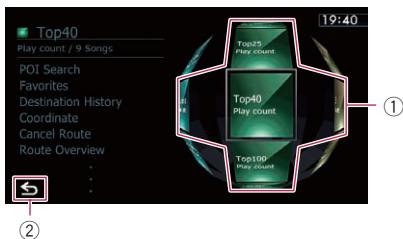

- 1 Plays the playlist**

Tapping a key moves the playlist to the center of the screen, and tapping the center key starts playback.

- ❑ To change the playlist to be displayed, rotate the sphere by dragging the keys up, down, left, or right.
- 2 Switches to the AV operation screen**

Using the "Function" menu

- ❑ If "Change Control Mode" is set to "iPod", only the setting of "Change Control Mode" is available.

- **Touch on the "iPod" screen.**
The "Function" menu appears.

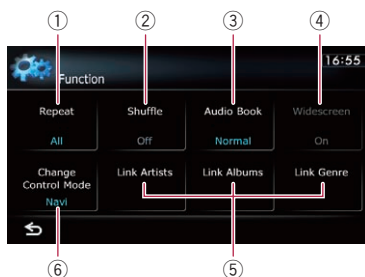

- 1 Sets repeat play**
There are two repeat play types for playback.
Each touch of **[Repeat]** changes the setting as follows:
 - **All:** Repeats all songs in the selected list.
 - **One:** Repeats just the current song.
- 2 Sets the shuffle play for music**
This function shuffles songs or albums and plays them in random order.
Each touch of **[Shuffle]** changes the setting as follows:
 - **Off:** Does not shuffle.
 - **Songs:** Plays back songs in random order within the selected list.
 - **Albums:** Selects an album randomly, and then plays back all songs in that album in order.

Using an iPod (iPod)

③ Sets the audiobook play speed

While listening to an audiobook on iPod, playback speed can be changed.

Each touch of [**Audio Book**] changes the setting as follows:

- **Normal:** Playback in normal speed
- **Faster:** Playback faster than normal speed
- **Slower:** Playback slower than normal speed

④ Plays video in wide screen mode

If the video is compatible with wide screen format, set "**Widescreen**" to "**On**" in order to view the video image in the wide screen.

Each touch of [**Widescreen**] changes the setting as follows:

- **On:** Outputs the wide screen video from iPod.
 - **Off:** Outputs the normal sized video from iPod.
- Display size is changed after you change "**Widescreen**" setting and select the video to play.
- This setting is available only during the video operation.

⑤ Plays songs related to the currently playing song

You can play songs related to the currently playing song, using of the following lists.

- **Link Artists:** Songs related to the currently playing artist will be played in the album order.
- **Link Albums:** Songs related to the currently playing album will be played.
- **Link Genre:** Songs related to the currently playing genre will be played in the artist order.

⑥ Sets iPod control mode

While the control mode is set to "**iPod**", you can operate iPod function from the connected iPod.

Each touch of [**Change Control Mode**] changes the setting as follows:

- **Navi:** Allows you to control the iPod functions from the navigation system.
- **iPod:** Allows you to control the iPod functions from the connected iPod.

IMPORTANT:

Requirements to access the Pandora music service using the Pioneer navigation system:

- Apple iPhone (first generation), iPhone 3G, or iPhone 3GS, with firmware version 3.0 or later.
- Latest version of the Pandora application for the iPhone, downloaded to your device. (Search Apple iTunes App Store for “Pandora”).
- Current Pandora account (Free account and paid accounts available from Pandora; create a free account online at <http://www.pandora.com/register> or through the Pandora application for the iPhone).
- iPhone Data Plan.

Note: if the Data Plan for your iPhone does not provide for unlimited data usage, *additional charges from AT&T may apply* for accessing the Pandora service via AT&T’s 3G and/or EDGE networks.
- Connection to the Internet via 3G, EDGE or WiFi network.
- Optional Pioneer adapter cable connecting your iPhone to the Pioneer navigation system.

Limitations:

- Access to the Pandora service will depend on the availability of a cellular and/or WiFi network for purposes of allowing your iPhone to connect to the Internet.
- Pandora’s service is currently only available in the U.S.
- Ability of the Pioneer navigation system to access the Pandora service is subject to change without notice and could be affected by any of the following: compatibility issues with future firmware versions of iPhones; compatibility issues with future firmware versions of the Pandora application for the iPhone; changes to the Pandora music service by Pandora; discontinuation of the Pandora music service by Pandora.
- Certain functionality of the Pandora service is not available when accessing the service through the Pioneer navigation system, including, but not limited to, creating new stations, deleting stations, emailing current

stations, buying songs from iTunes, viewing additional text information, logging in to Pandora, and adjusting Cell Network Audio Quality.

Pandora Internet radio is a music service not affiliated with Pioneer. More information is available at <http://www.pandora.com>. Pandora is a registered trademark of Pandora Media, Inc.

You can play the Pandora by connecting your iPod which was installed the Pandora application.

Starting procedure**1 Display the AV operation screen.**

- For details of the operations, refer to *Displaying the AV operation screen* on page 77.

2 Connect your iPod.

The source changes and then playback will start.

- For details, refer to *Connecting your iPod* on page 19.
- ☐ If the iPod is already connected, tap **[Pandora]** on the left edge of the screen.
- For details of the operations, refer to *Displaying the AV operation screen* on page 77.
- ☐ When an iPod is connected to the navigation system while the Pandora application is running, the “Pandora” screen appears after the “iPod” screen. Music may also be played back in the “iPod” screen.

3 Start up the Pandora application installed on the iPod.**4 Tap [Pandora] on the left end of the screen to display “Pandora” screen.****5 Use the touch panel keys on the screen to control the Pandora.**

- For details, refer to *Using the touch panel keys* on page 128. ■

Reading the screen

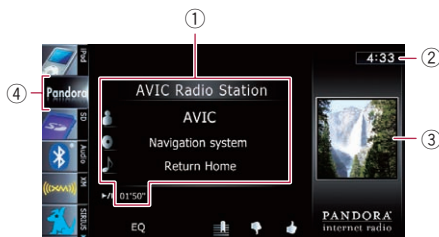

- ① **Current song information**
 - **Station name indicator**
Shows the Pandora station name the tuner is currently tuned in.
 - **🎤: Artist name**
Shows the artist name currently playing.
 - **📀: Album title**
Shows the title of the album for the current song.
 - **🎵: Song title**
Shows the title of the current song.
 - **Play time indicator**
Shows the elapsed playing time within the current song.
☐ "-----" is displayed if there is no corresponding information.
- ② **Current time**
- ③ **Album artwork**
Album art of the current song is displayed if it is available.
- ④ **Source icon**
Shows which source has been selected. ☐

Using the touch panel keys

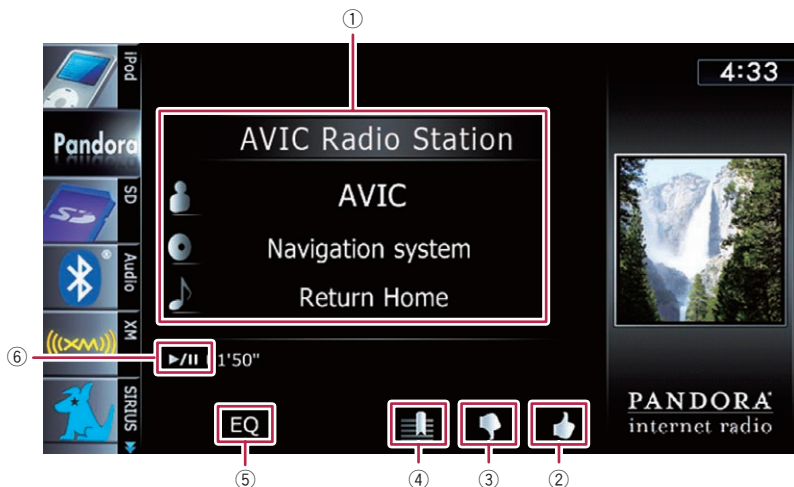

① Selects a Pandora station from the list

Touching the key displays the list of your Pandora stations to select one of them to play.

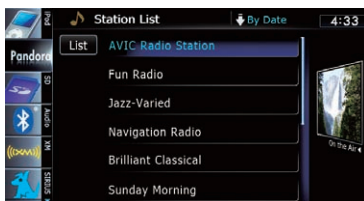

➔ For details, refer to *Operating list screens* (e.g. *iPod list screen*) on page 77.

Scroll by dragging items up or down, and display the item you want to select.

☐ Touching [QuickMix] plays only one song at a time from shuffled several stations.

☐ Each time you touch [List] changes the sort order.

Current order is indicated on the upper right of the screen.

- **By A-Z**:

You can sort the items in the list alphabetically.

- **By Date**:

You can sort the items in the list in order of dates the items were created.

② Thumbs Up

Touching the key gives "Thumbs Up" to the song currently playing.

③ Thumbs Down

Touching the key gives "Thumbs Down" to the song currently playing and skip to the next song.

④ Bookmark

Touching the key displays the screen which lets you select the artist or song to add book marks.

⑤ Recalls equalizer curves

➔ For details, refer to *Using the equalizer* on page 172.

⑥ Playback and Pause

Touching [▶/⏸] switches between playback and pause. ■

Using the Bluetooth audio player

You can control the Bluetooth audio player featuring Bluetooth wireless technology.

- ❑ Before using the Bluetooth audio player, you need to register and connect the device to this navigation system.

➔ For details, refer to *Registering your Bluetooth devices* on page 63.

- ❑ Depending on the Bluetooth audio player connected to this navigation system, the available operations with this navigation system are limited to the following two levels:

A2DP profile (Advanced Audio Distribution Profile): Only playing back songs on your audio player is possible.

A2DP profile and AVRCP profile (Audio/Video Remote Control Profile): Playing back, pausing, selecting songs, etc., are possible.

- ❑ Since there are a number of Bluetooth audio players available on the market, operations with your Bluetooth audio player using this navigation system vary greatly in range. Please refer to the instruction manual that came with your Bluetooth audio player as well as this manual while operating your player on this navigation system.
- ❑ While you are listening to songs on your Bluetooth audio player, please refrain from operating your cellular phone as much as possible. If you try operating on your cellular phone, the signal from your cellular phone may cause a noise on the song playback.
- ❑ Even if you switch to another source while listening to a song on your Bluetooth audio player, the playback of song continues to elapse.
- ❑ Depending on the Bluetooth audio player you connected to this navigation system, operations on this navigation system to control the player may differ from those explained in this manual.
- ❑ When you are talking on a cellular phone connected to this unit via Bluetooth wireless technology, song playback from your

Bluetooth audio player connected to this unit is paused.

Starting procedure

1 Display the AV operation screen.

- ➔ For details of the operations, refer to *Displaying the AV operation screen* on page 77.

2 Tap [Audio] on the left edge of the screen to display the "Audio" screen.

3 Use the touch panel keys on the screen to control the Bluetooth audio player.

- ➔ For details, refer to *Using the touch panel keys* on page 131. 

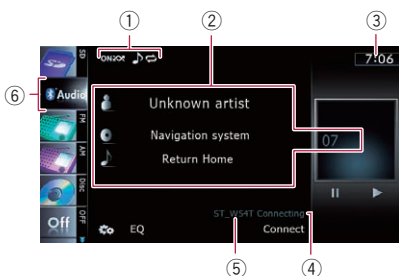

Reading the screen





① Playback condition indicator

Indicates the current playback condition if the connected Bluetooth audio player features AVRCP 1.3.

- Playing files in random order



Indicator:	Meaning
	Does not play files in random order.
	Plays all audio files in the current repeat play range in random order.

- Setting a repeat play range

Indicator:	Meaning
	Does not repeat.
	Repeats just the current file.
	Repeats all audio files in the Bluetooth audio player.

② Current file information

If the connected Bluetooth audio player features AVRCP 1.3, the following file information will be displayed.

-  **Artist name**
Shows the artist name currently playing (when available).
-  **Album title**
Shows the title of the album for the current file (when available).
-  **Track title**
Shows the title of the track currently playing (when available).
- **Play time indicator**
Shows the elapsed playing time within the current file.
- **File number indicator**
Shows the file number currently playing (when available).

In the following cases, file information will only be displayed after a file starts or resumes playing:

You connect the Bluetooth audio player compatible with AVRCP1.3, and operate the player to start playing.

You select another file when playback is paused.

③ Current time

④ Connection status indicator

Shows whether the device featuring Bluetooth technology is connected or not.

⑤ Device name indicator

⑥ Source icon

Shows which source has been selected.

Using the Bluetooth audio player

Using the touch panel keys

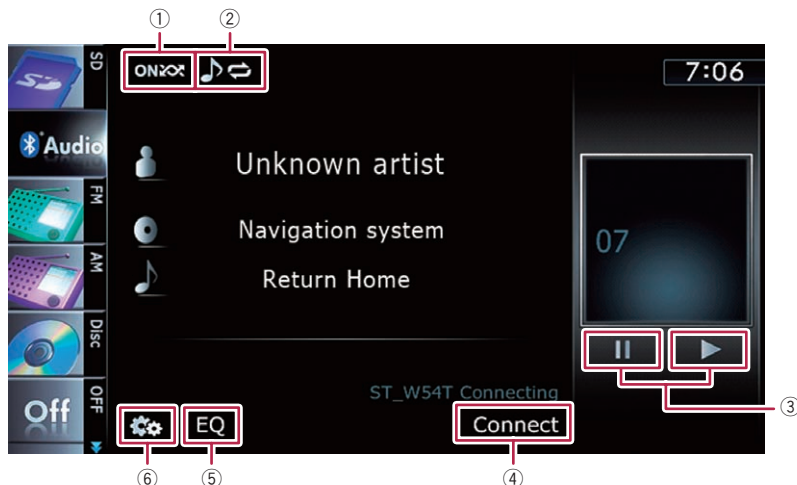

- ① **Plays files in random order**
All of the files within the repeat play range can be played at random by touching only one key.
 - ❑ This function is available only when the connected Bluetooth audio player features AVRCP 1.3.
 - ➔ For details, refer to **Plays files in random order** on the next page.
- ② **Sets a repeat play range**
The repeat play range can be changed by touching only one key.
 - ❑ This function is available only when the connected Bluetooth audio player features AVRCP 1.3.
 - ➔ For details, refer to **Changes the repeat range** on this page.
- ③ **Playback and Pause**
Touching [▶] or [⏸] switches between play back and pause.
- ④ **Connects the Bluetooth audio player**
Touching [Connect] displays the connection standby screen and the navigation system waits for the Bluetooth wireless connection request.
- ⑤ **Recalls equalizer curves**

➔ For details, refer to *Using the equalizer* on page 172.

- ⑥ **Displays the “Function” menu**
 - ➔ For details, refer to *Using the “Function” menu* on this page. ❑

Using the “Function” menu

- ❑ This menu is available only when the connected Bluetooth audio player features AVRCP 1.3.

- Touch  on the “Audio” screen. The “Function” menu appears.

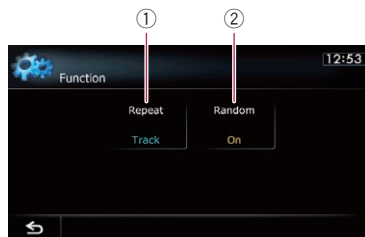

- ① **Changes the repeat range**

Each touch of [**Repeat**] changes the setting as follows:

- **All Repeat:** Repeats all audio files in the Bluetooth audio player.
 - **Track Repeat:** Repeats just the current file.
 - **Off:** Does not repeat.
- If you skip the file forward or backward when the repeat play range in "**Track Repeat**", the repeat play range changes to "**All Repeat**".

② **Plays files in random order**

Random play lets you playback files in random order within the current repeat range.

Each touch of [**Random**] turns it on or off.

Using the XM tuner

You can use the navigation system to control an XM satellite digital tuner, which is sold separately.

For details concerning operation, refer to the XM tuner's operation manuals. This section provides information on XM operations with the navigation system which differs from that described in the XM tuner's operation manual.

The following XM satellite digital tuner units cannot be connected:
GEX P900XM, GEX P910XM

Starting procedure

1 Display the AV operation screen.

- ➡ For details of the operations, refer to *Displaying the AV operation screen* on page 77.

2 Tap [XM] on the left edge of the screen to display the "XM" screen.

3 Use the touch panel keys on the screen to control the XM tuner.

- ➡ For details, refer to *Using the touch panel keys* on page 135. ■

Reading the screen

All CH Mode

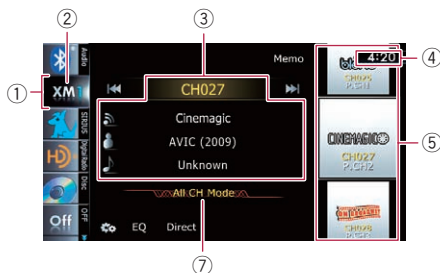

Category Mode



About the logo for channel name

Only the logo data that is contained in the navigation system can be displayed for each channel. The logo of a newly established channel that is not contained cannot be displayed. When a logo is not available, the following substitute icon is displayed.

Substitute icon



- The icon of each broadcast station is contained in the NAND flash memory based on the data provided by XM Satellite Radio as of September 2009.
- Any changes made by XM Satellite Radio in the lineup or icon of the broadcast station in the future may not be supported by the navigation system, and may cause the unit to display incorrect icons.

① Source icon

Shows which source has been selected.

② XM band indicator

Shows the XM band that has been selected.

③ Current XM station information

Shows the detailed information of the broadcast channel currently being received.

- **XM channel number**

Shows the XM channel number the tuner is currently tuned to.

- **XM station name**

Shows the XM broadcast station name the tuner is currently tuned in.

- **Artist (performer) name**

Using the XM tuner

Shows the artist (performer) name currently playing (when available).

-  **Song title (program name)**

Shows the title of the current song (program).

- "-----" is displayed if there is no corresponding information.

- ④ **Current time**

- ⑤ **XM station information**

- **XM station name logo**
- **XM channel number**
- **Preset number**

Shows what preset item has been selected.

- ⑥ **XM channel category**

Shows the category of broadcast channel.

- ⑦ **XM channel select mode indicator**

Shows what channel select mode has been selected. You can select a channel from all channels in **All CH Mode**, and select a channel from selected category in

Category Mode.

Using the XM tuner

Using the touch panel keys

All CH Mode

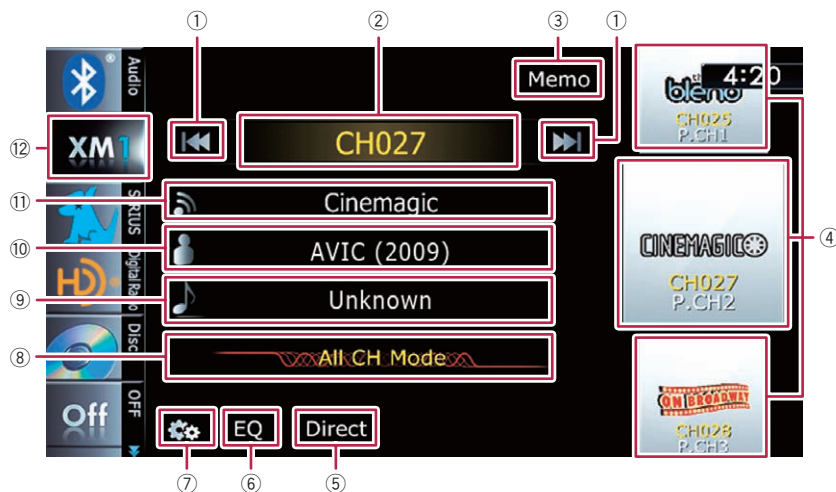

Category Mode

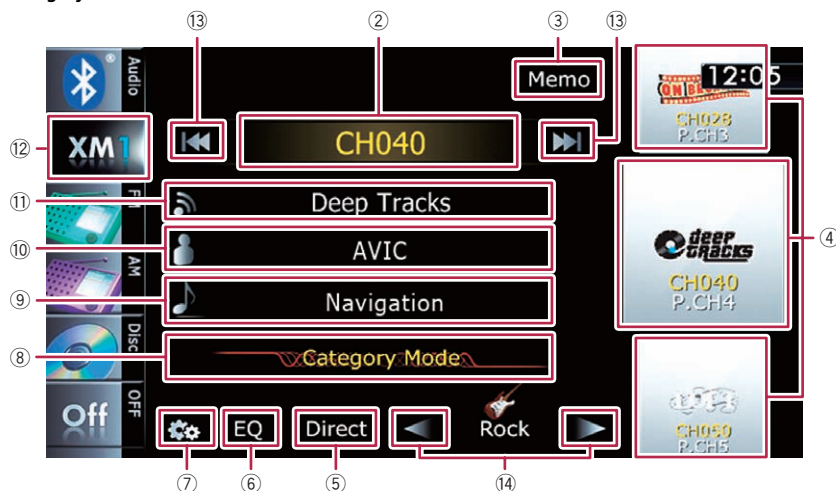

- ① **Performs manual tuning**
The channels move up or down one at a time.
□ If you keep touching [◀◀] or [▶▶] you can skip the broadcasting channels.
- ② **Switches between the AV operation screen and the preset list display**

You can switch the screen display according to your preference.

- ➡ For details of the operation, refer to **Switching between the AV operation screen and the list screen** on page 77.

- ③ **Memorizes the current song**

Using the XM tuner

- For details, refer to *Memorizing the song* on the next page.
- ④ **Recalls channels from the preset**
Once you have stored broadcast channels, you can easily recall preset channels from memory with a tap of a key.
 - For details, refer to *Storing and recalling broadcast stations* on this page.
- ⑤ **Selects an XM channel directly**
➤ For details, refer to *Selecting an XM channel directly* on this page.
- ⑥ **Recalls equalizer curves**
➤ For details, refer to *Using the equalizer* on page 172.
- ⑦ **Displays the “Function” menu**
➤ For details, refer to *Using the “Function” menu* on page 138.
- ⑧ **Switches the XM channel select mode**
You can switch the mode between the two methods for selecting and listing the channel.
All CH Mode:
You can select a channel from all channels when you operate this function.
Category Mode:
You can select a channel within a selected category that you operate this function.
- ⑨ **Switches to the list display of song titles**
➤ For details, refer to *Selecting a channel from the list* on the next page.
- ⑩ **Switches to the list display of artist names**
➤ For details, refer to *Selecting a channel from the list* on the next page.
- ⑪ **Switches to the list display of XM station names**
➤ For details, refer to *Selecting a channel from the list* on the next page.
- ⑫ **Selects an XM band**
Tapping the key repeatedly switches between the following XM bands: **XM 1**, **XM 2**, or **XM 3**.
 - ☐ This function is convenient for preparing different preset lists for each band.
- ⑬ **Performs manual tuning**
The channels move up or down one at a time within a selected category.

☐ If you keep touching [**◀◀**] or [**▶▶**] you can skip the broadcasting channels.

- ⑭ **Switches the channel category**
Touch [**◀**] or [**▶**] to select the desired category.

Selecting an XM channel directly

You can select an XM channel directly by entering the desired channel number.

1 Touch [Direct].

2 Touch [0] to [9] to input the desired channel number.

To cancel the input numbers one by one, touch **⏪**. Touching and holding **⏪** allows you to delete all input numbers.

3 While the input number is displayed, touch [Enter].

The XM channel that was entered is selected.

4 Touch **⏪.**

You return to the previous display.

Displaying the Radio ID

If you select CH: 000, the Radio ID is displayed.

1 Touch [Direct].

2 Input [000] and then touch [Enter].

☐ If you select another channel, display of the Radio ID is canceled.

3 Touch **⏪.**

You return to the previous display.

4 Wait until the Radio ID is displayed.

Storing and recalling broadcast stations

With a tap of any of the preset tuning keys (“P1” to “P6”), you can easily store up to six broadcast channels for later recall (also with the tap of a key).

Using the XM tuner

1 Select the channel that you want to store in memory.

2 Display the preset channel list.

- For details, refer to **Switches between the AV operation screen and the preset list display** on page 135.

3 Keep touching a preset tuning key [P1] to [P6].

The selected station has been stored in memory.

The next time you tap the same preset tuning key "P1" to "P6", the station is recalled from memory.

- Up to 18 stations, six for each of three XM bands can be stored in memory.

Selecting a channel from the list

The list content can be switched so you can search for the song you want to listen to not only by the channel name but also by the artist name or song title.

- The channel list shows all channels during **All CH Mode**, and the channels included in the selected category during **Category Mode**.

1 Display a list screen.

- For details, refer to **Switches to the list display of song titles** on the previous page.
- For details, refer to **Switches to the list display of artist names** on the previous page.
- For details, refer to **Switches to the list display of XM station names** on the previous page.

2 Touch [List].

XM channel list appears in the display. Each touch of [List] changes the screen as follows:

CH Name List (Channel name)

Song Title List (Song title)

Artist Name List (Artist name)

3 Tap the desired channel that you want to listen to.



- For details, refer to *Operating list screens (e.g. iPod list screen)* on page 77.
- During **Category Mode**, touch [◀] or [▶] to switch to another category.

Using "My Mix" function

"My Mix" function memorizes the song title and artist name of the song currently being received. When the song that matches the memorized song title and artist name is being broadcast on a station other than the one you are listening to, you will be alerted, and you can switch the station to listen to that song.

- A track itself is NOT downloaded. ONLY the song title and the artist name are memorized.

Memorizing the song

The song title and artist name of the song you are listening to can be memorized to "My Mix".

● Touch and hold [Memo].

The song title and artist name of current song you are listening to are memorized, and a confirmation message appears.

- The song title and artist name of up to 12 songs can be memorized. Trying to save more than 12 songs will result in older ones being overwritten.
- You cannot memorize the song title or the artist name when " " is displayed on the title information.
- This function is invalid for the channel "000".

Using the XM tuner

- ❑ The memorized title may not be displayed correctly depending on the conditions.
- ❑ You can customize the setting for the memorized songs later.
 - ➔ For more details concerning the operation, refer to *Setting the memorized songs* on this page.

When the memorized song is broadcast

A beep sounds, and a message is displayed. Touch **[Yes]** to switch to that station and listen to that track.

- ❑ If the memorized song is not checked or when **[Off]** is selected on **[Alert]** on **"Memo Edit"** screen, no alert will be provided.
 - ➔ Refer to *Setting the memorized songs* on this page.
- ❑ Notification may not be provided depending on the status of the navigation system.
- ❑ If there is even a slight difference between the memorized title and the title of the song being broadcast, no notification will be provided even though they are the same song. ❑

Using the "Function" menu

- Touch  on the "XM" screen.

The "Function" menu appears.

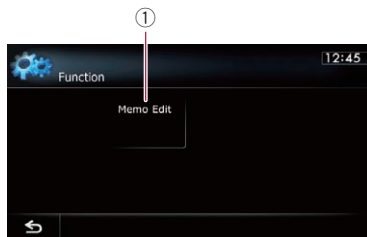

- ① Sets the memorized songs

Setting the memorized songs

Selecting the songs to alert

The list of song titles memorized for the MyMix Function (MyMix list) is displayed. You can change the notification setting when the song is broadcast again. You can enable or disable notification for each song.

- 1 Touch **[Memo Edit]**.

- 2 Touch the song title that you want to disable notification for.

The check mark is removed, and the notification setting of the song is deactivated.

Changing the alert setting

You can enable or disable alerts for all items at the same time. This function is useful when you want to turn alerts off temporarily without changing each memorized song.

- 1 Touch **[Memo Edit]**.

- 2 Touch **[Alert]**.

Each touch of **[Alert]** turns it on or off.

Deleting the memorized songs

You can delete each one of the memorized songs from the song title list.

- 1 Touch **[Memo Edit]**.

- 2 Touch and hold the song you want to delete.

- ❑ To delete all songs that are memorized, touch **[Delete All]**.

- 3 Touch **[Yes]**. ❑

Using the SIRIUS tuner

You can use the navigation system to control a Pioneer Sirius Satellite Radio tuner, which is sold separately.

For details concerning operation, refer to the SIRIUS tuner's operation manuals. This section provides information on SIRIUS operations with navigation system which differs from that described in the SIRIUS tuner's operation manual.

- When you use the SiriusConnect universal tuner (sold separately) with this navigation system, Pioneer SIRIUS BUS INTERFACE is required. For details concerning operation, refer to the owner's manual of Pioneer SIRIUS BUS INTERFACE and SiriusConnect universal tuner.

Starting procedure

1 Display the AV operation screen.

- ➔ For details of the operations, refer to *Displaying the AV operation screen* on page 77.

2 Tap [SIRIUS] on the left edge of the screen to display the "SIRIUS" screen.

3 Use the touch panel keys on the screen to control the SIRIUS tuner.

- ➔ For details, refer to *Using the touch panel keys* on the next page. □

Reading the screen

All CH Mode

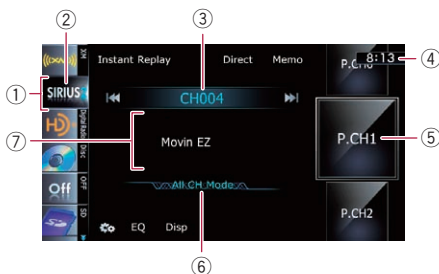

Category Mode

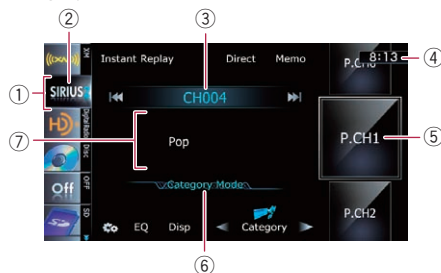

1 Source icon

Shows which source has been selected.

2 SIRIUS band indicator

Shows the SIRIUS band that has been selected.

3 SIRIUS channel number indicator

Shows the SIRIUS channel number that the tuner is tuned to.

4 Current time

5 Preset number indicator

Shows what preset item has been selected.

6 SIRIUS channel select mode indicator

Shows what channel select mode has been selected. You can select a channel from all channels in **All CH Mode**, and select a channel from the selected category in **Category Mode**.

- ➔ For details concerning operations, refer to **Switches the SIRIUS channel select mode** on page 141.

7 Variable information area

Shows various information about the broadcast channel currently being received.

- ➔ For more details about the displayed information, refer to **Switches the SIRIUS display** on page 141. □

Using the touch panel keys

All CH Mode

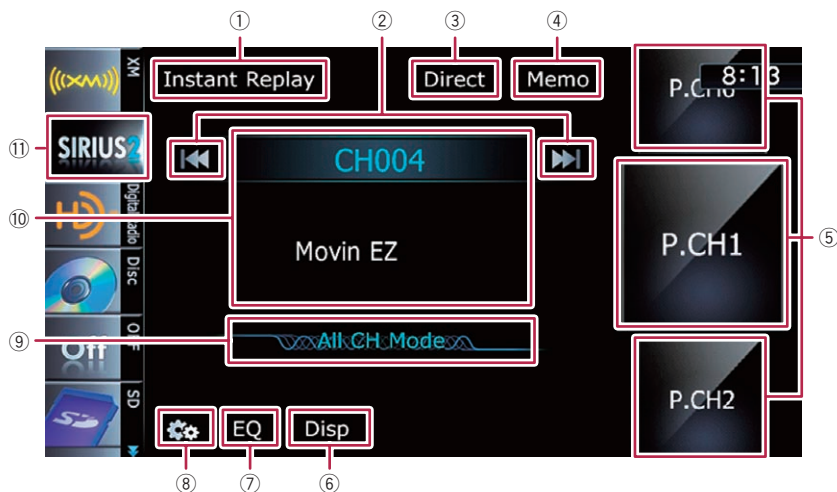

Category Mode

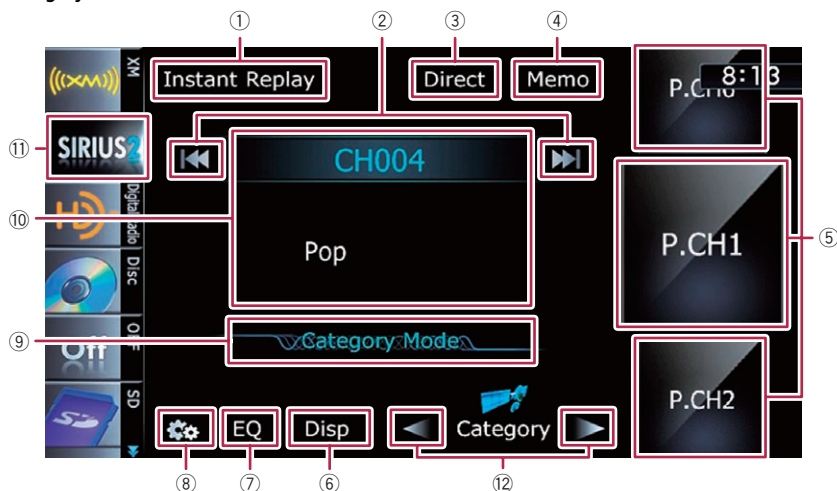

- ① **Switches the SIRIUS Instant replay mode**
 ➔ For details, refer to *Using the "Instant Replay" function* on page 142.
- ② **Performs manual tuning**
 The channels move up or down one at a time.

- ☐ If you keep touching [◀◀] or [▶▶] you can skip the broadcasting channels.
- ③ **Selects a SIRIUS channel directly**
 ➔ For details, refer to *Selecting a SIRIUS channel directly* on the next page.
- ④ **Memorizes the current song**

Using the SIRIUS tuner

- ➔ For details, refer to *Memorizing the song* on the next page.
- ⑤ **Recalls channels from the preset**
Tap to recall the preset channel.
- ➔ For details, refer to *Storing and recalling broadcast stations* on this page.
- ⑥ **Switches the SIRIUS display**
Each touch of [Disp] changes the display in formation.
- | Channel number | Channel name | Channel category | Artist name/feature | Song/program title | Composer |
|----------------|--------------|------------------|---------------------|--------------------|----------|
| | | | | | |
- ⑦ **Recalls equalizer curves**
➔ For details, refer to *Using the equalizer* on page 172.
- ⑧ **Displays the “Function” menu**
➔ For details, refer to *Using the “Function” menu* on page 143.
- ⑨ **Switches the SIRIUS channel select mode**
You can switch the mode between the two methods for selecting and listing the channel.
- All CH Mode:**
You can select a channel from all channels when you operate this function.
- Category Mode:**
You can select a channel within a selected category that you operate this function.
- ⑩ **Switches between the AV operation screen and the preset list display**
You can switch the screen display according to your preference.
- ➔ For details of the operation, refer to *Switching between the AV operation screen and the list screen* on page 77.
- ⑪ **Selects a SIRIUS band**
Tapping the key repeatedly switches between the following SIRIUS bands: **SIRIUS1**, **SIRIUS2**, or **SIRIUS3**.
- ☐ This function is convenient for preparing different preset lists for each band.
- ⑫ **Switches the channel category**
Touch [◀] or [▶] to select the desired category.

Selecting a SIRIUS channel directly

You can select a SIRIUS channel directly by entering the desired channel number.

- 1 **Touch [Direct].**
- 2 **Touch [0] to [9] to input the desired channel number.**
To cancel the input numbers one by one, touch . Touching and holding allows you to delete all input numbers.
- 3 **While the input number is displayed, touch [Enter].**
The SIRIUS channel that was entered selected.
- 4 **Touch .**
You return to the previous display.

Display the Radio ID

If you select CH: 000, the Radio ID is displayed.

- 1 **Touch [Direct].**
- 2 **Input [000] and then touch [Enter].**
If you select another channel, display of the Radio ID is canceled.
- 3 **Touch .**
You return to the previous display.
- 4 **Wait until the Radio ID is displayed.**

Storing and recalling broadcast stations

With a tap of any of the preset tuning keys (“Preset 1” to “Preset 6”), you can easily store up to six broadcast stations for later recall (also with the tap of a key).

- 1 **Select the channel that you want to store in memory.**

Using the SIRIUS tuner

2 Display the preset channel list.

- ➔ For details, refer to **Switches between the AV operation screen and the preset list display** on the previous page.

3 Keep touching a preset tuning key [Preset 1] to [Preset 6].

The selected station has been stored in memory.

The next time you tap the same preset tuning key "Preset 1" to "Preset 6" the station is recalled from memory.

- ❑ Up to 18 stations, six for each of three SIRIUS bands can be stored in memory.

Using "My Mix" function

The MyMix function memorizes the song title and artist name of the song currently being received. When a track that matches the memorized song title and artist name is being broadcast on a station other than the one you are listening to, you will be alerted, and you can switch the station to listen to that song.

- ❑ The track itself is NOT downloaded; only the song title and the artist name are memorized.

Memorizing the song

The song title and artist name of the song you are listening to can be memorized.

● Touch and hold [Memo].

The song title and artist name of the song you are listening to can be memorized.

- ❑ Up to 10 song titles and artist names can be memorized.
- ❑ You cannot memorize a song that does not have song title and artist name information.
- ❑ You cannot memorize the song title or the artist name of channel "000".
- ❑ The memorized title may not be displayed correctly.

When the memorized song is broadcast

A beep sounds, and a message is displayed.

Touch [Jump] to switch to that station, and you can listen to that track. If you touch [Stay], the channel does not switch.

- ❑ If the alert for the song is "Off" or set "Alert" to "Off", no notification will be provided even when that song is broadcast.
 - ➔ For details, refer to **Setting the memorized songs** on the next page.
- ❑ Notification may not be provided depending on the situation of the Navigation System.
 - ➔ For details, refer to *Selecting the songs to alert* on the next page.

Using the "Instant Replay" function

The "Instant Replay" function allows you to replay the stored broadcast on Pioneer SIRIUS BUS INTERFACE (if Pioneer SIRIUS BUS INTERFACE capable for this function). As soon as you tune to a channel, Pioneer SIRIUS BUS INTERFACE automatically begins storing the broadcast. It can store approximately up to 44 minutes previous (depending on the selected channel and the memory capacity of Pioneer SIRIUS BUS INTERFACE).

1 Touch [Instant Replay] on the SIRIUS screen to activate the "Instant Replay" mode.

2 Touch keys for "Instant Replay".

Touch panel keys	Action
[◀◀]	Return to the start of the current song or program. Touching again will skip back to the previous song or program.
[◀◀] and hold	Fast reverses.
[▶▶]	Forwards play to the next song or program
[▶▶] and hold	Fast forwards.
[▶]	Touching [▶] switches between playback and pause.

Using the SIRIUS tuner

- ❑ During “Instant Replay” mode, each touch of [Disp] changes the display information as follows:
Time position Channel number Channel name Channel category Artist name/feature Song/program title Composer
- ❑ You cannot replay the broadcast prior to the beginning of stored data. 

Using the “Function” menu

- Touch  on the “SIRIUS” screen. The “Function” menu appears.

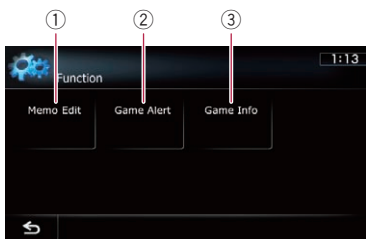

- ① Sets the memorized songs
 - ② Uses the Game Alert function
 - ③ Displays Game Information
- ➔ For details of each function, refer to sections below with the relative titles.

Setting the memorized songs

Selecting the songs to alert

You can change the setting of the alert when the track is broadcast again. You can enable or disable alert for each song.

- 1 Touch [Memo Edit].

- 2 Touch [◀ Prev] or [Next ▶] to select the desired song.

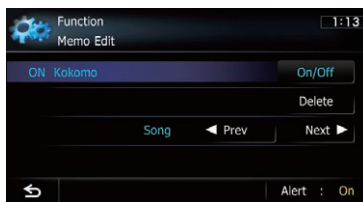

- 3 Touch [On/Off] to turn the setting on. When the alert for the song is activated, [On] appears at the beginning of the selected title.
 - ❑ Touch [On/Off] again to turn the setting off.

Changing the alert setting

You can enable or disable alerts for all items at the same time. This function is useful when you want to turn alerts off temporarily without changing each memorized song.

- 1 Touch [Memo Edit].
- 2 Touch [Alert].
Each touch of [Alert] turns it on or off.

Deleting the memorized songs

You can delete each one of the memorized tracks from the song title list.

- 1 Touch [Memo Edit].
- 2 Touch [◀ Prev] or [Next ▶] to select the song title that you want to delete.
- 3 Touch [Delete] when the song you want to delete is displayed.
A message will appear asking you to confirm the deletion.
- 4 Touch [Yes].

Using the Game Alert function

Selecting teams for Game Alert

This navigation system can alert you when games involving your favorite sports teams are about to start. To use this function you need to store the teams you want to follow in advance.

- 1 Touch **[Game Alert]**.
- 2 Touch **[◀ Prev]** or **[Next ▶]** to select the league.

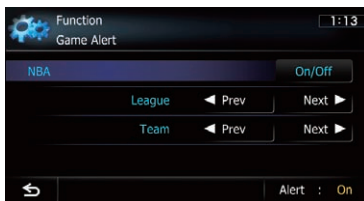

- 3 Touch **[◀ Prev]** or **[Next ▶]** to select the team.
- 4 Touch **[On/Off]**.

The team displayed as **[On]** is the alert target.

- ❑ When the selected team is excluded from the alert target, the team is displayed as **[Off]**. Up to 12 teams can be selected. When you have already made 12 team selections, **"FULL"** is displayed and additional team selection is not possible. In this case, first delete the team selection and then try again.

Changing the alert setting

You can enable or disable the alert for selected items. This function is useful when you want to turn the alert off temporarily without changing the setting of each selected team.

- 1 Touch **[Game Alert]**.
- 2 Touch **[Alert]**.
Each touch of **[Alert]** turns it on or off.

When a game involving one of your teams is broadcast

A message is displayed. Touch **[Jump]** to switch the station, and you can view the game information. If you touch **[Stay]**, the channel does not switch.

- ❑ Alerts may not be provided depending on the status of the navigation system.

Displaying Game Information

An alert will be displayed when a game with the team you selected is about to start (or is currently under way). You can also display game information and changes to the broadcast channel.

- ❑ The Game Information function is available when **"Alert"** is **"On"** in **"Game Alert"**.

- 1 Touch **[Game Info]**.
- 2 Touch **[Prev]** or **[Next]** to view the game score information which is registered.
 - ❑ The game score will be updated automatically.
 - ❑ Touch **[Tune To]** to switch to the channel that broadcasts the displayed game.
 - ❑ If you have not made any team selections, **"Not Set"** is displayed.
 - ❑ When no games involving your favorite teams are currently being played **"NO GAME"** is displayed. ❑

Using AV input

You can display the video image output by the equipment connected to the navigation system. For details of the connection method, refer to Installation Manual.

CAUTION

For safety reasons, video images cannot be viewed while your vehicle is in motion. To view video images, you must stop in a safe place and apply the parking brake.

Reading the screen

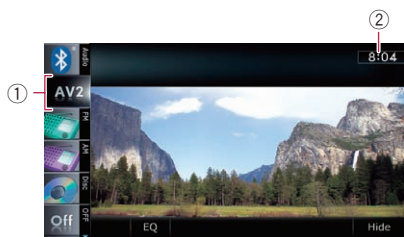

- ① **Source icon**
Shows which source has been selected.
- ② **Current time**

Using AV1

You can display the video image output by the equipment connected to video input 1.

1 Touch [AV1 Input] on the “AV System Settings” menu.

- For details, refer to *Setting video input 1 (AV1)* on page 168.

2 Display the AV operation screen.

- For details of the operations, refer to *Displaying the AV operation screen* on page 77.

3 Tap [AV1] on the left edge of the screen.

The image is displayed on the screen.

4 Touch the screen to display the touch panel keys.

Using AV2

You can display the video image output by the equipment connected to video input 2.

1 Touch [AV2 Input] on the “AV System Settings” menu.

- For details, refer to *Setting video input 2 (AV2)* on page 168.

2 Display the AV operation screen.

- For details of the operations, refer to *Displaying the AV operation screen* on page 77.

3 Tap [AV2] on the left edge of the screen.

The image is displayed on the screen.

4 Touch the screen to display the touch panel keys.

Using the touch panel keys

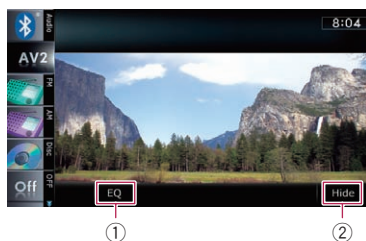

① Recalls equalizer curves

- For details, refer to *Using the equalizer* on page 172.

② Hides the touch panel keys

- Touching [**Hide**] hides the touch panel keys. Touch anywhere on the LCD screen to display the touch panel keys again.

The term “external unit” refers to future Pioneer devices that are not currently planned for, or to devices that allow control of basic functions although they are not fully controlled by the navigation system. Two external units can be controlled by this navigation system. When two external units are connected, the navigation system allocates them as external unit 1 or external unit 2.

For details of the connection method, refer to Installation Manual.

For details of the operation, refer to the external unit's operation manual. This section provides information on external unit operations with the navigation system that differ from those described in the external unit's operation manual.

- Operation varies depending on the external unit connected. (In some cases, the external unit may not respond.)

Starting procedure

1 Display the AV operation screen.

- ☞ For details of the operations, refer to *Displaying the AV operation screen* on page 77.

2 Tap [EXT1] or [EXT2] on the left edge of the screen to select the external unit.

3 Use the touch panel keys on the screen to control the external unit.

- ☞ For details, refer to *Using the touch panel keys* on the next page. □

Reading the screen

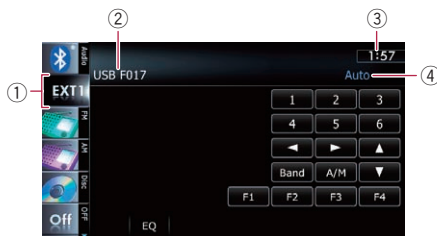

- ① **Source icon**
Shows which source has been selected.
- ② **External unit indicator**
Displays the information that is sent by connected external units.
- ③ **Current time**
- ④ **Auto/Manual mode indicator**
Shows the current mode. □

Using the external unit (EXT1, EXT2)

Using the touch panel keys

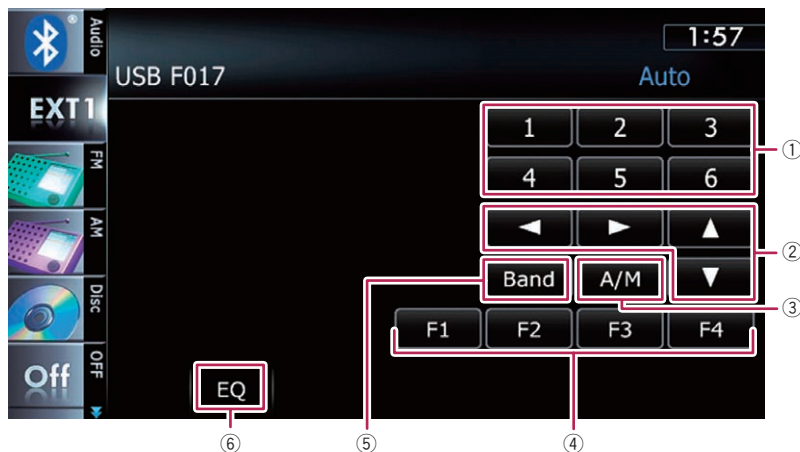

① Sends a [1] key to [6] key command

The external unit can be operated by transmitting the operating commands set to "1" key through "6" key.

- ❑ Operation varies depending on the external unit connected. (In some cases, some functions may not be used until you touch and hold the key.)

② Sends a command [▲], [▼], [◀], or [▶]

Touch to operate the external unit.

- ❑ Operation varies depending on the external unit connected. (In some cases, some functions may not be used until you touch and hold the key.)

③ Switches between automatic and manual function

You can turn automatic and manual function on or off.

You can switch between "Auto" and "Manual" functions of the external unit connected.

Initially, this function is set to "Auto".

- ❑ Operating commands set for "Auto" and "Manual" operations vary depending on the external unit connected.

④ Uses [F1] through [F4] to operate the external unit

The external unit can be operated by transmitting the operating commands set to "F1" through "F4".

- ❑ The operating commands set to "F1" through "F4" vary depending on the external unit.
- ❑ Some functions may not be used until you touch and hold the key.

⑤ Sends a band command

Touch to send a band command to the external unit.

- ❑ Operation varies depending on the external unit connected. (In some cases, the external unit may not respond.)

⑥ Recalls equalizer curves

- ➔ For details, refer to *Using the equalizer* on page 172. ❑

Displaying the “Navi Settings” screen

1 Press the HOME button to display the “Top Menu” screen.

2 Touch [Settings].

The “Settings Menu” screen appears.

- This can also be operated using the “Short cut Menu” screen.

3 Touch [Navi Settings].

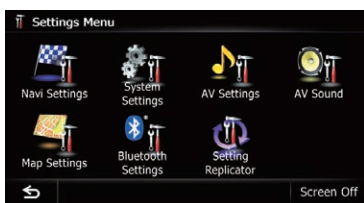

The “Navi Settings” menu appears.

4 Touch the item that you want to change the setting.

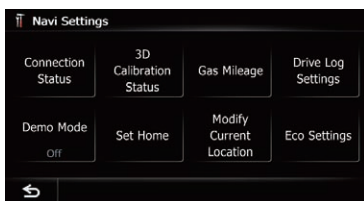

- Touch .

The previous screen returns.

Checking the connections of leads

Check that leads are properly connected between the navigation system and the vehicle. Please also check whether they are connected in the correct positions.

1 Display the “Navi Settings” screen.

- ➔ For details, refer to *Displaying the “Navi Settings” screen* on this page.

2 Touch [Connection Status].

The “GPS Status” screen appears.

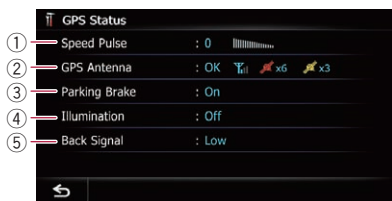

① **Speed Pulse**

The Speed Pulse value detected by the navigation system is shown. “0” is shown while the vehicle is stationary.

② **GPS Antenna**

Indicates the connection status of the GPS antenna, the reception sensitivity, and from how many satellites the signal is received.

Color	Signal communication	Used in positioning
Orange	Yes	Yes
Yellow	Yes	No

- When the GPS antenna is connected to this navigation system, “OK” is displayed.

When the GPS antenna is not connected to this navigation system, “NOK” is displayed.

- If reception is poor, please change the installation position of the GPS antenna.

③ **Parking Brake**

When the parking brake is applied, “On” is displayed. When the parking brake is released, “Off” is displayed.

④ **Illumination**

When the headlights or small lamps of a vehicle are on, “On” is displayed. When the small lamps of a vehicle are off, “Off” is displayed. (If the orange/white lead is not connected, “Off” appears.)

⑤ **Back Signal**

Customizing preferences

When the gear lever is shifted to “**R**”, the signal switches to “**High**” or “**Low**”. (One of these is displayed depending on the vehicle.)

Checking sensor learning status and driving status

- ❑ The navigation system can automatically use its sensor memory based on the outer dimensions of the tires.

1 Display the “Navi Settings” screen.

- ➔ For details, refer to *Displaying the “Navi Settings” screen* on the previous page.

2 Touch [3D Calibration Status].

The “**3D Calibration Status**” screen appears.

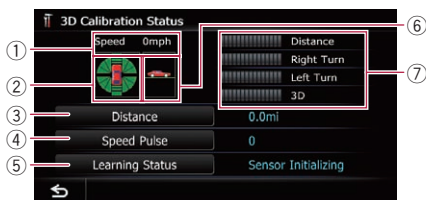

① Speed

Indicates the speed detected by the navigation system. (This indication may be different from the actual speed of your vehicle, so please do not use this instead of the speedometer.)

② Acceleration or deceleration/Rotational speed

Indicates acceleration or deceleration velocity of your vehicle. Also, rotational speed when your vehicle turns to left or right is shown.

③ Distance

Indicates driving distance.

④ Speed Pulse

Indicates the total number of speed pulses.

⑤ Learning Status

Indicates the current driving mode.

⑥ Inclination

Indicates the degree of slope of the street that you are currently on.

⑦ Degree of learning

Sensor learning situations for distance (**Distance**), right turn (**Right Turn**), left turn (**Left Turn**) and 3D detection (**3D**) are indicated by the length of bars.

- ❑ When tires have been changed or chains fitted, turning on the Speed Pulse allows the system to detect the fact that the tire diameter has changed, and automatically replaces the value for calculating distance.
- ❑ If a separately sold speed pulse generator (ND PG1) is connected, the distance calculation value cannot be replaced automatically.

Clearing status

You can delete the learned results stored in [**Distance**], [**Speed Pulse**] or [**Learning Status**].

1 Touch [Distance] or [Speed Pulse].

The following message appears.



2 Touch [Yes].

Clears the results stored in [**Distance**] or [**Speed Pulse**].

3 Touch [Learning Status].

The following message appears.



4 Touch [All].

Clears all learning statuses.

- Touch **[All]** for the following cases:
 - After changing the installation position of the navigation system
 - After changing the installation angle of the navigation system
 - After moving the navigation system to another vehicle
- Touch **[Distance]**.

Clears the learned results stored in **[Distance]**.

- When the distance accuracy is low, touch **[Distance]**. 

Using the “Gas Mileage” function

Inputting the fuel consumption information for calculating the fuel cost

You can estimate the fuel cost to your destination by entering the fuel consumption information in the navigation system.

➔ For details, refer to *Setting a route to your destination* on page 31.

1 Display the “Navi Settings” screen.

- ➔ For details, refer to *Displaying the “Navi Settings” screen* on page 148.

2 Touch [Gas Mileage].

The “Gas Mileage Setting” screen appears.

3 Enter the fuel consumption information.

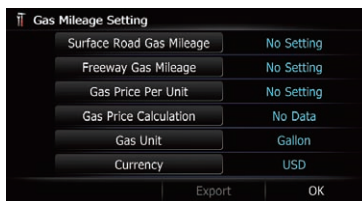

Enter the following items:

- **Surface Road Gas Mileage:**

Enter the fuel cost when you drive on ordinary roads.

 - How the fuel cost is entered depends on the “**Gas Unit**” setting.
 - When “**Gas Unit**” is set to “**Liter**”. Enter how much fuel you need to travel 60 miles (100 kilometers).
 - When “**Gas Unit**” is set to “**Gallon**”. Enter how many kilometers (miles) you get to a gallon.
- **Freeway Gas Mileage:**

Enter the fuel cost when you drive on the freeway.

 - How the fuel cost is entered depends on the “**Gas Unit**” setting.
 - When “**Gas Unit**” is set to “**Liter**”. Enter how much fuel you need to travel 60 miles (100 kilometers).
 - When “**Gas Unit**” is set to “**Gallon**”. Enter how many kilometers (miles) you get to a gallon.
- **Gas Price Per Unit:**

Enter the fuel unit price.
- **Gas Unit:**

Set the fuel unit.
- **Currency:**

Set the unit of currency.

When all the items are entered, inputting the fuel consumption information is complete.

Customizing preferences

Calculating the fuel consumption

When you enter the fueling information to the navigation system, and export the data to SD memory cards, you can check the fuel consumption information by using the utility program AVIC FEEDS, which is available separately, on your PC.

- ❑ Up to 24 sets of data can be stored. You can also export the data, as described below.
- If the entries reach the maximum number, a new entry will overwrite the oldest one.

These calculations are based only on the information that you provide and not on any data from the vehicle. The fuel mileage displayed is only a reference value, and does not guarantee the fuel mileage displayed can be obtained.

1 Display the "Navi Settings" screen.

- ➔ For details, refer to *Displaying the "Navi Settings" screen* on page 148.

2 Touch [Gas Mileage].

The "Gas Mileage Setting" screen appears.

3 Touch [Gas Price Calculation].

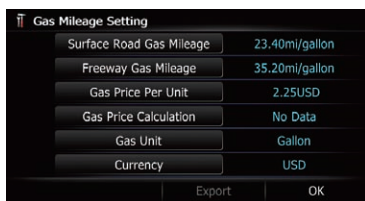

The "Gas Price Calculation" screen appears.

4 Enter the fuel consumption information.

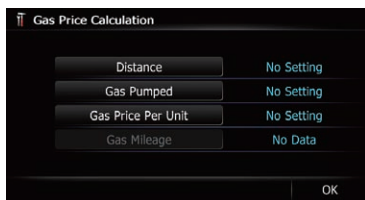

Enter the following items:

- **Distance:**
Enter the distance traveled since the previous fueling.
 - ❑ The distance is entered automatically only when the distance traveled since the previous fueling is recorded.
- **Gas Pumped:**
Enter the amount of fuel pumped.
- **Gas Price Per Unit:**
Enter the fuel unit price.

When all the items are entered, the fuel consumption is displayed next to "Gas Mileage".

5 Touch [OK].

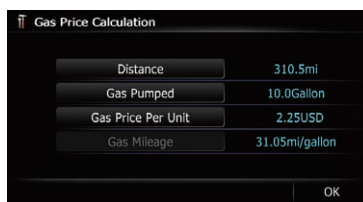

The "Gas Mileage Setting" screen appears.

Exporting the data of fuel cost information

Exporting the fuel cost data to an SD memory card is possible.

- ❑ The data stored in this navigation system will be cleared as exporting it to the SD memory card.
- ❑ If there is previous data in the SD memory card, the data is overwritten with new data when current data is exported.

1 Insert an SD memory card into the SD card slot.

- ➔ For details of the operation, refer to *Inserting and ejecting an SD memory card* on page 15.

2 Display the "Navi Settings" screen.

- ➔ For details, refer to *Displaying the "Navi Settings" screen* on page 148.

3 Touch [Gas Mileage].

The "Gas Mileage Setting" screen appears.

4 Touch [Export].

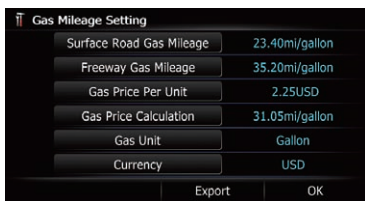

After a message confirming whether to export the data appeared, exporting the data to the SD memory card starts.

The “**Gas Mileage Setting**” screen appears when it is done.

Recording your travel history

Activating the track logger enables you to record your driving history (called “track log” below). You can review the travel history later.

If an SD memory card is inserted into the SD card slot, the track logs will be stored in the SD memory card.

1 Insert an SD memory card into the SD card slot.

➔ For details of the operation, refer to *Inserting and ejecting an SD memory card* on page 15.

2 Display the “Navi Settings” screen.

➔ For details, refer to *Displaying the “Navi Settings” screen* on page 148.

3 Touch [Drive Log Settings].

The “**Drive Log Settings**” screen appears.

4 Touch [Drive Log Settings].

Each time you touch the key changes that setting.

- **On:**
You can export your track log to the SD memory card.
- **Off** (default):
You cannot export your track log to the SD memory card.
- While the setting is “**On**”, the navigation system continues to store the track logs in the inserted SD memory card.

5 Touch [Type].

Each time you touch the key changes that setting.

- **Private** (default):
Changes the track log attribute to “**Private**”.
- **Business:**
Changes the track log attribute to “**Business**”.
- **Other:**
Changes the track log attribute to “**Other**”.

Using the demonstration guidance

This is a demonstration function for retail stores. After a route is set, touching this key starts the simulation of route guidance.

1 Display the “Navi Settings” screen.

➔ For details, refer to *Displaying the “Navi Settings” screen* on page 148.

2 Touch [Demo Mode].

Each time you touch the key changes that setting.

- **On:**
Repeats demo drive.
- **Off** (default):
Demo Mode is set off.

3 Display the map screen.

The demonstration guidance will begin.

Registering your home

Registering your home position saves time and effort. Also, routes to home positions can be calculated easily with a single touch of the key from the “**Destination Menu**”. The registered home position can also be modified later.

1 Display the “Navi Settings” screen.

➔ For details, refer to *Displaying the “Navi Settings” screen* on page 148.

2 Touch [Set Home].

The “**Set Home**” screen appears.

Customizing preferences

3 Touch [Home].

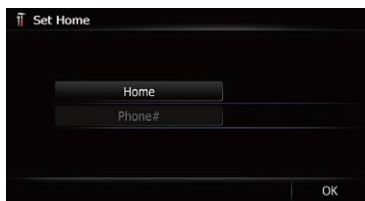

The “**Select Search method**” screen appears.

- Touch [**Phone#**].

When you have already registered your home, you can edit your home number.

4 Search for a location.

➔ For details, refer to Chapter 6.

After searching for a point, the map of the selected position is displayed.

5 Touch [OK].

The location is registered, and then the “**Set Home**” screen appears.

6 Touch [OK].

The registration is completed.

Correcting the current location

Touch the screen to adjust the current position and direction of the vehicle displayed on the map.

1 Display the “Navi Settings” screen.

➔ For details, refer to *Displaying the “Navi Settings” screen* on page 148.

2 Touch [Modify Current Location].

3 Scroll to the position where you want to set, then touch [OK].

4 Touch the arrow key on the screen to set the direction, then touch [OK].

Changing the eco-function setting

You can change the eco function setting.

1 Display the “Navi Settings” screen.

➔ For details, refer to *Displaying the “Navi Settings” screen* on page 148.

2 Touch [Eco Settings].

The “**Eco Settings**” screen appears.

3 Touch each item.



Eco Score

- **On** (default):
Displays “**Eco Score**”.
 - **Off**:
Hides “**Eco Score**”.
- ➔ For details, refer to *Displaying “Eco Graph”* on page 31.

Eco Drive Level

- **On** (default):
After you arrive the destination, a message appears and a beep sounds if the level of “**Eco Drive Level**” have increased or decreased.
- **Off**:
No message appears and no sound beeps when the vehicle reaches the destination.

➔ For details, refer to *Displaying Eco Drive Level guidance* on page 32.

Rapid Start Warning

- **On**:
A message appears and a sound beeps when the vehicle experiences a sudden start.
- **Off** (default):
No message appears and no sound beeps when the vehicle experiences a sudden start.

➔ For details, refer to *Sudden start alert* on page 32.

Clear Eco Record

Fuel consumption data are cleared.

4 Touch [OK].

The settings are completed.

Displaying the “Map Settings” screen

- 1 Press the HOME button to display the “Top Menu” screen.
- 2 Touch [Settings].

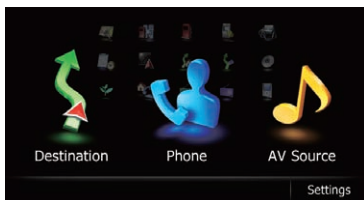

The “Settings Menu” screen appears.

- 3 Touch [Map Settings].

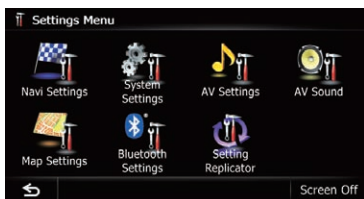

The “Map Settings” screen appears.

- 4 Touch the item that you want to change the setting.

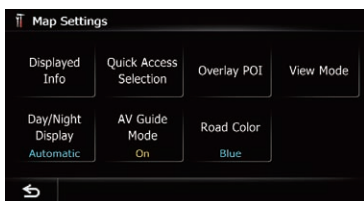

- Touch .

The previous screen returns. .

- 1 Display the “Map Settings” screen.

- For details, refer to *Displaying the “Map Settings” screen* on this page.

- 2 Touch [Displayed Info].

The “Displayed Information” screen appears.

- 3 Touch [Close Up View].

Each time you touch the key changes that setting.

- **On** (default):
Switches to an enlarged map.
- **Off**:
Does not switch to an enlarged map. .

Setting the auto-zoom display

This setting enables switching to an enlarged map around the point where your vehicle is approaching an intersection, entrance/exit of freeway or a junction.

Customizing preferences

Setting the detailed city map

You can select whether to display the city map when in certain metropolitan city areas.

- The detailed city map and this setting are available for AVIC Z120BT only.
- The city map is displayed when the map scale is 0.05 mile (50 meters) or less.

1 Display the “Map Settings” screen.

- ➔ For details, refer to *Displaying the “Map Settings” screen* on the previous page.

2 Touch [Displayed Info].

The “**Displayed Information**” screen appears.

3 Touch [City Map].

Each time you touch the key changes that setting.

- **On** (default):
Automatically switches to the city map when in a city map area.
- **Off**:
Does not show the city map.
 - Even if you switch “**City Map**” to “**On**”, city map cannot be displayed in areas where there is no city map data.

Setting the barrier graphic for city map

On the city map screen, you can display a “barrier graphic” pattern where no city map data is available. This prevents a normal map of a different scale from being displayed at the same time, greatly enhancing the clarity of the city map on screen.

- The detailed city map and this setting are available for AVIC Z120BT only.

1 Display the “Map Settings” screen.

- ➔ For details, refer to *Displaying the “Map Settings” screen* on the previous page.

2 Touch [Displayed Info].

The “**Displayed Information**” screen appears.

3 Touch [City Map Barrier].

Each time you touch the key switches between “**On**” and “**Off**”.

- **On** (default):
Displays the barrier graphic for city map. When the vehicle position or cursor enters the barrier graphic area, the graphic disappears and a normal map is displayed full screen.
- **Off**:
Does not display the barrier graphic for city map. When the vehicle position or cursor enters the area where no city map data is available, a normal map is displayed full screen.

Displaying the traffic notification icon

Selects whether to display or hide the traffic notification icons on the map when incidents occur on your route.

- ➔ For details, refer to *Checking traffic information manually* on page 58.

1 Display the “Map Settings” screen.

- ➔ For details, refer to *Displaying the “Map Settings” screen* on the previous page.

2 Touch [Displayed Info].

The “**Displayed Information**” screen appears.

3 Touch [Show Traffic Incident].

Each time you touch the key changes that setting.

- **View** (default):
Displays the icons on the map.
- **Hide**:
Hides the icons on the map.

Displaying the Bluetooth connection icon

Selects whether to display or hide the icon for current status of the phone connection via Bluetooth wireless technology.

1 Display the “Map Settings” screen.

- ➔ For details, refer to *Displaying the “Map Settings” screen* on page 154.

2 Touch [Displayed Info].

The “Displayed Information” screen appears.

3 Touch [Bluetooth Connected].

Each time you touch the key changes that setting.

- **View** (default):
Displays the Bluetooth connection icon on the map.
- **Hide:**
Hides the Bluetooth connection icon on the map.
- ➔ For details about the Bluetooth connection icon, refer to *Bluetooth connection icon* on page 26.

Setting the current street name display

Selects whether to display or hide the street name (or city name) that your vehicle is traveling along.

1 Display the “Map Settings” screen.

- ➔ For details, refer to *Displaying the “Map Settings” screen* on page 154.

2 Touch [Displayed Info].

The “Displayed Information” screen appears.

3 Touch [Current Street Name].

Each time you touch the key changes that setting.

- **View** (default):
Displays the street name (or city name) on the map.
- **Hide:**
Hides the street name (or city name) on the map.

Setting the “Favorites” icon display

You can select whether to display the “Favorites” icon on the map.

- Favorites** icons are displayed when the map scale is 10 mile (20 kilometers) or less.
- ➔ For details, refer to *Editing the entry in the “Favorites” list* on page 46.

1 Display the “Map Settings” screen.

- ➔ For details, refer to *Displaying the “Map Settings” screen* on page 154.

2 Touch [Displayed Info].

The “Displayed Information” screen appears.

3 Touch [Favorites Icon].

Each time you touch the key changes that setting.

- **On** (default):
Displays the “Favorites” icon on the map.
- **Off:**
Hides the “Favorites” icon on the map.

Displaying the 3D landmarks

You can select whether to display the 3D landmark on the map.

- The 3D landmarks and this setting are available for AVIC Z120BT only.
- 3D landmark only appears when the view mode is “3D View” and the map scale is set to 0.25 mile (200 m) or lower.

1 Display the “Map Settings” screen.

- ➔ For details, refer to *Displaying the “Map Settings” screen* on page 154.

2 Touch [Displayed Info].

The “Displayed Information” screen appears.

3 Touch [3D Land Mark].

Each time you touch the key changes that setting.

- **On** (default):
Displays the 3D landmark on the map.
- **Off:**
Hides the 3D landmark on the map.

Customizing preferences

Displaying maneuvers

Selects whether to display or hide maneuvers on the map.

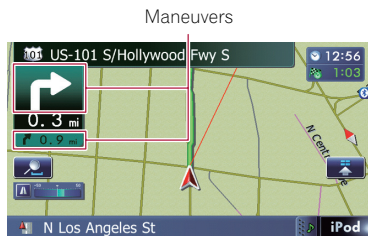

1 Display the “Map Settings” screen.

- ➔ For details, refer to *Displaying the “Map Settings” screen* on page 154.

2 Touch [Displayed Info].

The “Displayed Information” screen appears.

3 Touch [Show Maneuver].

Each time you touch the key changes that setting.

- **View** (default):
Displays maneuvers on the map.
- **Hide:**
Hides maneuvers on the map.

Displaying the MSN Direct icons

Selects whether to display or hide the received MSN Direct icons on the map.

- ➔ For details of the icons, refer to *How to read MSN Direct information on the map* on page 54.

● Touch [MSN Direct].

Each time you touch the key changes that setting.

- **On** (default):
Displays the icons on the map.
- **Off:**
Hides the icons on the map.

Displaying the fuel consumption information

Selects whether to display Eco Meter, indicating the fuel consumption information, on the map.

- Eco Meter appears when “2D View” or “3D View” is selected.

1 Display the “Map Settings” screen.

- ➔ For details, refer to *Displaying the “Map Settings” screen* on page 154.

2 Touch [Displayed Info].

The “Displayed Information” screen appears.

3 Touch [Show Eco Meter].

Each time you touch the key changes that setting.

- **View** (default):
Displays Eco Meter on the map.
- **Hide:**
Hides Eco Meter on the map.

Displaying POI on the map

Displays icons for the surrounding facilities (POI) on the map.

- POI icons are not displayed when the map scale is 0.75 mile (1 kilometers) or more.

Displaying preinstalled POIs on the map

- You can select up to 10 items from the sub categories or detailed categories.

1 Display the “Map Settings” screen.

- ➔ For details, refer to *Displaying the “Map Settings” screen* on page 154.

2 Touch [Overlay POI].

The “Overlay POI” screen appears.

3 Touch [Display] to change the setting to "On".

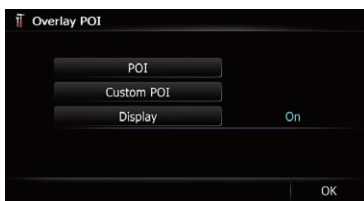

- If you do not want to display the POI icon on the map, touch [Display] to turn it "Off". (Even if "Display" is turned "Off", the POI selection setting is retained.)

4 Touch [POI].

The "Overlay POI (Main Category)" screen appears.

5 Touch the main category you want.

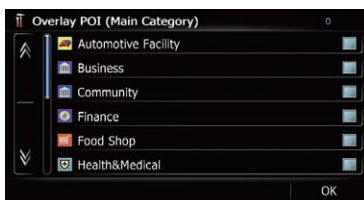

A list of subcategories under the selected main category appears.

- Categories that are already selected will have a blue check mark.

6 Touch the subcategory to display.

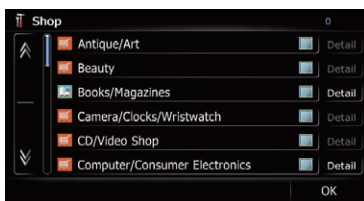

A red check mark appears next to the selected category. To cancel the selection, touch the entry again.

If there are more detailed categories within the subcategory, [Detail] is active. If you select the subcategory that has more detailed cate-

gories, all detailed categories within the subcategory is selected and [Detail] becomes inactive.

- Touch [Detail].

The detailed category list is displayed. Touch the item and touch [OK] to complete selecting the detailed categories you want to display.

- When only a few types of the detailed categories are selected, blue check marks will appear.

7 Touch [OK].

The "Overlay POI (Main Category)" screen returns.

If you want to select or deselect other items, repeat these steps as many as necessary.

8 To finish the selection, touch [OK] in the "Overlay POI (Main Category)" screen.

Displaying the customized POIs

Creating a customized POI is possible by using the utility program AVIC FEEDS which is available separately, on your PC. (AVIC FEEDS will be available on our website.) Storing the customized POI properly and inserting the SD memory card enables the system to display the icons on the map screen.

- You can select up to 10 items from the subcategories or detailed categories.

1 Insert an SD memory card into the SD card slot.

- For details of the operation, refer to *Inserting and ejecting an SD memory card* on page 15.

2 Display the "Map Settings" screen.

- For details, refer to *Displaying the "Map Settings" screen* on page 154.

3 Touch [Overlay POI].

The "Overlay POI" screen appears.

Customizing preferences

4 Touch [Display] to change the setting to "On".

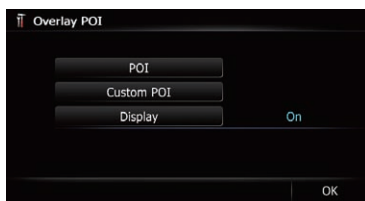

- ❑ If you do not want to display the POI icon on the map, touch **[Display]** to turn it "Off". (Even if "Display" is turned "Off", the POI selection setting is retained.)

5 Touch [Custom POI].

The list of POI categories appears.

6 Touch the items you want to display.

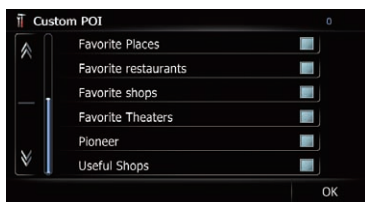

7 To finish the selection, touch [OK].

2 Touch [Day/Night Display].

Each time you touch the key changes that setting.

- **Automatic** (default):
You can change the colors of a map between daytime and nighttime according to whether the vehicle lights are on or off.
- **Day**:
The map is always displayed with daytime colors.
- ❑ To use this function with "Automatic", the orange/white lead of the navigation system must be connected correctly.

Changing the road color

You can set the road color to bluish or reddish.

1 Display the "Map Settings" screen.

- ➔ For details, refer to *Displaying the "Map Settings" screen* on page 154.

2 Touch [Road Color].

Each time you touch the key changes that setting.

- **"Blue"** (default):
Changes to blue based road colors.
- **"Red"**:
Changes to red based road colors.

Changing "View Mode"

Various types of screen displays can be selected for navigation guidance.

- ➔ For details of the operation, refer to *Switching the view mode* on page 29.

Setting the map color change between day and night

To improve the visibility of the map during the evening, you can set the timing for changing the combination of the map color.

1 Display the "Map Settings" screen.

- ➔ For details, refer to *Displaying the "Map Settings" screen* on page 154.

Changing the setting of navigation interruption screen

Set whether to automatically switch to the navigation screen from the audio screen when your vehicle approaches a guidance point such as an intersection while displaying a screen other than navigation.

1 Display the "Map Settings" screen.

- ➔ For details, refer to *Displaying the "Map Settings" screen* on page 154.

2 Touch [AV Guide Mode].

Each time you touch the key changes that setting.

- **On** (default):
Switches from the AV operation screen to the map screen.
- **Off**:
Does not switch the screen.
- ☐ This setting is effective only when "Close Up View" is set to "On". 

Selecting the "Quick Access" menu

Select items to display on the map screen. In the list displayed on screen, the items with red checks are displayed on the map screen. Touch the item you want to display and then touch [OK] when a red check appears. You can select up to five items.

1 Display the "Map Settings" screen.

- ➔ For details, refer to *Displaying the "Map Settings" screen* on page 154.

2 Touch [Quick Access Selection].











The "Quick Access Selection" screen appears.

3 Touch the item that you want to set in "Quick Access".

You can select the following items:

- ☐ Settings marked with an asterisk (*) show that these are default or factory settings.
- : **Registration***

Register information on the location indicated by the cursor to "Favorites".

- ➔ For details, refer to *Registering a location by scroll mode* on page 46.
- : **Vicinity Search***
Find POIs (Points Of Interest) in the vicinity of the cursor.
➔ For details, refer to *Searching for a nearby POI* on page 37.
- : **Overlay POI***
Displays icons for surrounding facilities (POI) on the map.
➔ For details, refer to *Displaying POI on the map* on page 157.
- : **Volume***
Displays the "Volume Settings" screen.
➔ For details, refer to *Setting the Volume for Guidance and Phone* on page 163.
- : **Contacts***
Displays the "Contacts List" screen.
➔ For details, refer to *Calling a number in the "Contacts List"* on page 69.
- : **Whole Route Overview**
Displays the entire route (currently set) with the "Route Overview" screen.
➔ For details, refer to *Displaying the "Route Overview" screen* on page 42.
- : **Stock Info**
Displays stock prices.
➔ For details, refer to *Browsing stock quotes* on page 61.
- : **Traffic On Route**
Displays a list of traffic information on the route.
➔ For details, refer to *Checking traffic information on the route* on page 56.
- : **Traffic Events**
Displays a list of traffic events information.
➔ For details, refer to *Checking all traffic information* on page 55.
- : **Day/Night Display**
Switches **Day/Night Display** setting.
➔ For details, refer to *Setting the map color change between day and night* on the previous page.
- : **Favorites Icon**
Switches **Favorites Icon** setting.

Customizing preferences

- ➔ For details, refer to *Setting the “Favorites” icon display* on page 156.

4 To finish the setting, touch [OK].

Displaying the “System Settings” screen

1 Press the HOME button to display the “Top Menu” screen.

2 Touch [Settings].

The “Settings Menu” screen appears.

- This can also be operated using the “Short cut Menu” screen.

3 Touch [System Settings].

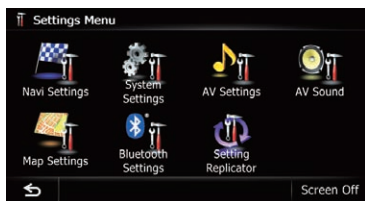

The “System Settings” screen appears.

4 Touch the item that you want to change the setting.

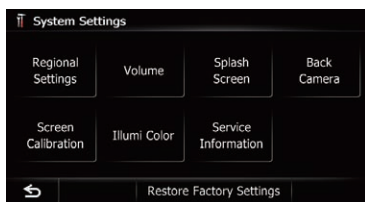

- Touch [←].

The previous screen returns.

Customizing the regional settings

1 Display the “System Settings” screen.

- ➔ For details, refer to *Displaying the “System Settings” screen* on this page.

2 Touch [Regional Settings].

The “Regional Settings” screen appears.



Selecting the language

You can set the languages used on the program and voice guidance. Each language can be set separately.

1 Display the “System Settings” screen.

- ➔ For details, refer to *Displaying the “System Settings” screen* on this page.

2 Touch [Regional Settings].

The “Regional Settings” screen appears.

3 Touch [Program Language].

The “Select Program Language” screen appears.

4 Touch the desired language.

After the language is selected, the previous screen returns.

5 Touch [Voice Language].

The “Voice Language Selection” screen appears.

6 Touch the desired language.

After the language is selected, the previous screen returns.

7 Touch [OK] on the “Regional Settings” screen.

A message confirming whether to restart the navigation system appears.

8 Touch [OK].

The navigation system restarts.

- Press the **MODE** button or the **HOME** button. Cancels the setting of the languages.

Setting the time difference

Adjusts the system's clock. Set the time difference (+, -) from the time originally set in your navigation system.

1 Display the "System Settings" screen.

- ➔ For details, refer to *Displaying the "System Settings" screen* on the previous page.

2 Touch [Regional Settings].

The "Regional Settings" screen appears.

3 Touch [Time].

The "Time Settings" screen appears.

4 To set the time difference, touch [+] or [-].

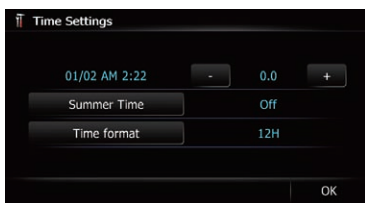

The time difference between the time originally set in the navigation system (Pacific Standard Time) and the current location of your vehicle is shown. If necessary, adjust the time difference. Touching [+] or [-] changes the time difference display in half hour increments.

The time difference can be set from **-4** to **+9** hours.

5 Touch [Summer Time].

If necessary, set to summer time. Summer time setting is off by default. Touch [Summer Time] to change the setting if you are in the summer time period.

6 Touch [Time format].

Each time you touch the key changes that setting.

- **12H** (default):
Changes the display to 12 hour format with am/pm.
- **24H**:
Changes the display to 24 hour format.

Changing the unit between km and miles

This setting controls the unit of distance and speed displayed on your navigation system.

1 Display the "System Settings" screen.

- ➔ For details, refer to *Displaying the "System Settings" screen* on the previous page.

2 Touch [Regional Settings].

The "Regional Settings" screen appears.

3 Touch [km / mile].

A message confirming whether to change the setting appears.

4 Touch [Yes].

Each time you touch the key changes that setting.

- **mile** (default):
Shows distance in miles.
- **Mile&Yard**:
Shows distance in miles and yards.
- **km**:
Shows distance in kilometers.

▪ Touch [No].

Cancels the setting.

Changing the virtual speed of the vehicle

When calculating the expected time of arrival and the travel time to the destination, set the average speed for the freeway or ordinary roads using [+] and [-].

1 Display the "System Settings" screen.

- ➔ For details, refer to *Displaying the "System Settings" screen* on the previous page.

2 Touch [Regional Settings].

The "Regional Settings" screen appears.

3 Touch [Average Speed].

The "Average Speed Settings" screen appears.

Customizing preferences

4 Touch [+] or [-] to set the speed.



- The estimated time of arrival is not necessarily estimated based on this speed value.

5 Touch [OK].

The settings are completed.

Setting the Volume for Guidance and Phone

The sound volume for the navigation can be set. You can separately set the volume of the route guidance and the beep sound.

1 Display the "System Settings" screen.

- ➔ For details, refer to *Displaying the "System Settings" screen* on page 161.

2 Touch [Volume].

The "Volume Settings" screen appears.

3 Touch [+] or [-] to set their volume.

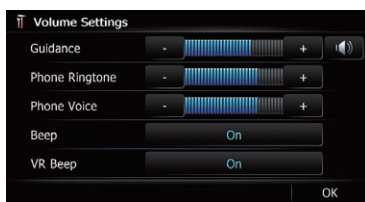

On this screen, you can operate the following items.

- **Guidance**
This setting controls the guidance volume of navigation.
 - When set to guidance is output.
 - When set to no guidance is output.
- **Phone Ringtone**
This setting controls the incoming ring tone volume.

• Phone Voice

This setting controls the incoming voice volume.

- "Phone Ringtone" and "Phone Voice" adjustments are related to the cellular phone featuring Bluetooth technology. No adjustment is needed when the cellular phone featuring Bluetooth technology is not connected.
- Volume of the AV source is adjusted by the **VOL (+/-)** button.
 - ➔ For details, refer to *Checking part names and functions* on page 12.
- Touch the key next to "Beep".
Each time you touch the key changes that setting.
 - **On** (default):
A beep sounds.
 - **Off**:
The beep sound is muted.
- Touch the key next to "VR Beep".
Each time you touch the key changes that setting.
 - **On** (default):
Voice recognition beep is enabled.
 - **Off**:
Voice recognition beep is disabled.

4 To finish the setting, touch [OK].

Changing the preinstalled splash screen

You can change the splash screen to the other images preinstalled in the navigation system.

1 Display the "System Settings" screen.

- ➔ For details, refer to *Displaying the "System Settings" screen* on page 161.

2 Touch [Splash Screen].

The "Select Splash Screen" screen appears.

3 Touch the image to use as the splash screen from the list.

The image is displayed on the screen.

4 Touch [OK].

The image is set as the splash screen, and the “**System Settings**” screen returns.

Changing to the splash screen stored in the SD memory card

You can change the splash screen that appears when the navigation system starts. Copy your chosen image to the SD memory card, and select the image to import.

- Splash screen images should be used with in the following formats;
 - BMP or JPEG files
 - Allowable horizontal and vertical size are 2 592 pixels x 1 944 pixels or smaller
 - Allowable data size is 6 MB or smaller
- Proper compatibility with allowable files is not guaranteed.
- Imported original images will be stored in the built in memory, but the ability to save these images cannot be guaranteed completely. If your original image data is deleted, insert the SD memory card again and re import the original image.
- The maximum number of images, including the images in the built in memory, that can be imported and displayed on the list is 200.

1 Create a folder named “Pictures” on the top-most directory of the SD memory card and store the picture files in this folder.

2 Store the picture files in the “Pictures” folder.

3 Insert an SD memory card into the SD card slot.

- ➔ For details of the operation, refer to *Inserting and ejecting an SD memory card* on page 15.

4 Display the “System Settings” screen.

- ➔ For details, refer to *Displaying the “System Settings” screen* on page 161.

5 Touch [Splash Screen].

The “**Select Splash Screen**” screen appears.

6 Touch [Select from SD].

The “**Select Splash Screen**” screen appears.

7 Touch the image to use as the splash screen from the list.

The image is displayed on the screen.

8 Touch [OK].

The image is set as the splash screen, and the “**System Settings**” screen returns.

- Images imported from the SD memory card are added to the list on “**Select Splash Screen**”.

Setting for rear view camera

The following two functions are available. The rear view camera feature requires a separately sold rear view camera (e.g. ND BC4). (For details, consult your dealer.)

Rear view camera

The navigation system features a function that automatically switches to the full screen image of the rear view camera installed on your vehicle. When the shift lever is in the REVERSE (R) position, the screen automatically switches to full screen rear view camera image.

Camera for Rear view mode

“**Rear View**” can be displayed at all times (e.g. when monitoring an attached trailer, etc.) as a split screen where map information is partially displayed. Please be aware that with this setting, camera image is not resized to fit, and that a portion of what is seen by the camera is not viewable.

- ➔ For details, refer to *Setting for rear view camera* on this page.

**CAUTION**

Pioneer recommends the use of a camera which outputs mirror reversed images, otherwise the screen image may appear reversed.

Customizing preferences

- ❑ Immediately verify whether the display changes to a rear view camera image when the shift lever is moved to REVERSE (R) from another position.

- ❑ When the screen changes to full screen rear view camera image during normal driving, switch to the opposite setting in “Polarity”.

1 Display the “System Settings” screen.

- For details, refer to *Displaying the “System Settings” screen* on page 161.

2 Touch [Back Camera].

The “Back Camera Settings” screen appears.

3 Touch [Camera] change the setting to “On”.

- ❑ You can only switch to “Rear View” if this setting is “On”.

4 Touch [Polarity] to select an appropriate setting for polarity.

Each time you touch [Polarity] switches between the following polarity:

- **Battery:** When the polarity of the connected lead is positive while the shift lever is in the REVERSE (R) position
- **GND:** When the polarity of the connected lead is negative while the shift lever is in the REVERSE (R) position

Adjusting the response positions of the touch panel (touch panel calibration)

If you feel that the touch panel keys on the screen deviate from the actual positions that respond to your touch, adjust the response positions of the touch panel screen.

- ❑ Do not use a sharp pointed tool such as a ballpoint pen or a mechanical pen, which could damage the screen.

1 Display the “System Settings” screen.

- For details, refer to *Displaying the “System Settings” screen* on page 161.

2 Touch [Screen Calibration].

A message confirming whether to start the calibration appears.

3 Gently touch the center of + mark displayed on the screen.

The target indicates the order.

After you touch all marks, the adjusted position data is saved.

- ❑ Do not turn off the engine while saving the adjusted position data.

- Press the **MODE** button.

Returns to the previous adjustment position.

- Press and hold the **MODE** button.

Cancels the adjustment.

Setting the illumination color

The illumination color can be selected from 10 different colors. Furthermore, the illumination color can be switched between these 10 colors in order.

Selecting the color from the preset colors

1 Display the “System Settings” screen.

- For details, refer to *Displaying the “System Settings” screen* on page 161.

2 Touch [Illumi Color].

The “Illumination Color” screen appears.

3 Touch the color you want.



Available options:

- Colored keys: Selects the desired preset color
- **Memory 1/Memory 2**: Colors registered in the memory

- ➔ For details, refer to *Creating a user defined color and storing it to memory* on this page.
- **Scan:** Shifts between the eight default colors in sequence gradually.
- **Eco:** The colors change in the order of white, red, amber, yellow, green, and blue as the number of points in the “**Eco Score**” increases.
 - The illumination lights in white when “**Eco Score**” is set to “**Off**” or when no route is set.

Creating a user-defined color and storing it to memory

You can create a user defined color and set it as the illumination color.

1 Display the “System Settings” screen.

- ➔ For details, refer to *Displaying the “System Settings” screen* on page 161.

2 Touch [Illumi Color].

The “**Illumination Color**” screen appears.

3 Touch [Custom].

The “**Illumination Color**” screen appears.

- If [Scan] is set, [Custom] cannot be selected.

4 Touch [+] or [-] to adjust the values for Red, Green and Blue to create a favorite color.



Watch the illumination of hardware keys while adjusting the color.

Each time you touch [+] or [-] increases or decreases the value of the selected item. +31 to +00 is displayed as the value is increased or decreased.

- An entry cannot be stored with all of the values set to “+00”.

5 Touch [Memory 1] or [Memory 2] to store the illumination color.

6 Touch [OK] to return to the previous screen.

Checking the version information

1 Display the “System Settings” screen.

- ➔ For details, refer to *Displaying the “System Settings” screen* on page 161.

2 Touch [Service Information].

The “**Service Information Screen**” screen appears.

3 Check the version information.

Selecting the video for “Rear display”

- This function is available for AVIC Z120BT only.

You can choose either to show the same image as the front screen or to show the selected source on the “Rear display”.

● Tap on the left edge of the screen.

- The appearance of this key changes according to the current setting.

Each touch of  changes the settings as follows:

- **Mirror AV:** The video on the front screen of the navigation unit is output to the “Rear display”
- **DISC:** The video and sound of the DVDs are output to the “Rear display”
- **iPod:** The video and sound of the iPod or Pandora are output to the “Rear display”
- **AV1:** The video and sound of **AV1** are output to the “Rear display”
- **AV2:** The video and sound of **AV2** are output to the “Rear display”
- When “**Mirror AV**” is selected, the following restrictions are applied to “Rear display”.

Customizing preferences

When selecting "**Rear View**" in the map display, nothing is displayed.

All sounds cannot be output for "Rear display".

When playing back video files on the external storage device (USB, SD), the video image is not output.

- ❑ When "**DISC**" is selected, the following restriction is applied to "Rear display".
 - When a CD or MP3/WMA/AAC disc is set in the built in DVD drive, only the sound is output.
- ❑ When "**iPod**" is selected, the following restriction is applied to "Rear display".
 - The video image and sound are output only when the appropriate setting on "**AV1 Input**" is "**iPod**".
- ❑ When "**AV**" is selected, the following restrictions are applied to "Rear display".
 - The video image and sound are output only when **AV1/AV2** has both video and sound.
 - The video image and sound are output only when the appropriate setting on "**AV1 Input**" or "**AV2 Input**" are "**Video**".

Adjusting the picture

⚠ CAUTION

For safety reasons, you cannot use some of these navigation functions while your vehicle is in motion. To enable these functions, you must stop in a safe place and apply the parking brake. Refer to Important Information for the user (a separate manual).

You can adjust the picture for each source and rear view camera.

1 Press and hold the MODE button.

The "**Picture Adjustment**" screen appears.

2 Touch [+] or [-] to adjust the desired item.



- **Brightness:** Adjusts the black intensity.
- **Contrast:** Adjusts the contrast.
- **Color:** Adjusts the color saturation.
- **Color Temp.:** Adjusts the tone of color (red is emphasized or green is emphasized).
- **Dimmer:** Adjusts the brightness of display.
- ❑ Touching [**Camera**] switches to the picture adjustment screen for the rear view camera.
- ❑ Touching [**Source**] while adjusting the rear view camera image returns you to the previous screen.
- ❑ The adjustments of **Brightness** and **Contrast** are stored separately when your vehicle's headlights are off (daytime) and when your vehicle's headlights are on (nighttime). These are switched automatically depending on whether the vehicle's headlights are on or off.
- ❑ The adjustments of **Dimmer** is stored separately when your vehicle's headlights are off (daytime) and when your vehicle's headlights are on (nighttime). **Dimmer** is switched automatically only when the value of nighttime is lower than the value of daytime.
- ❑ You cannot adjust **Color** for the source without a video and navigation map display.
- ❑ The setting contents can be memorized separately for the following screen and the video image.

AM/FM/CD/ROM/iPod(Music)/Pandora/SD(audio)/USB(audio)/Bluetooth Audio/XM/SIRIUS/Digital Radio screen
AV1 and iPod(Video)
DVD-V and DivX
SD(Video) and USB(Video)

AV2(Video) and **EXT1**(Video), **EXT2** (Video)

Rear view camera image

Map screen

- The picture adjustment may not be available with some rear view cameras.
- Because of the LCD screen characteristics, you may not be able to adjust the screen at low temperatures.

3 Touch [+] **or [-]** to adjust the desired item.

Each touch of **[+]** or **[-]** increases or decreases the level of the desired item.

4 Touch **[↶]** to return to the previous screen.

Displaying the “AV System Settings” screen

1 Press the HOME button to display the “Top Menu” screen.

2 Touch **[Settings]**.

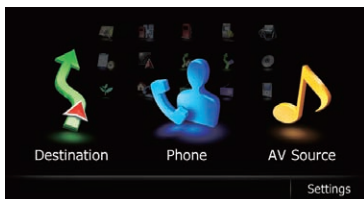

The “Settings Menu” screen appears.

3 Touch **[AV Settings]**.

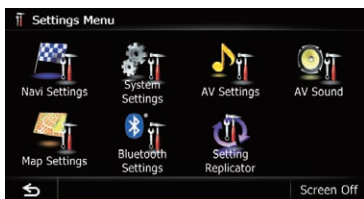

The “AV System Settings” menu appears.

4 Touch the item that you want to change the setting.



- You can only adjust “Wide Mode” when selecting an AV source with video.

▪ Touch **[↶]**.

The previous screen returns.

Setting video input 1 (AV1)

You can switch this setting according to the connected component.

- This setting applies to mini jack input.

1 Display the “AV System Settings” screen.

- For details, refer to *Displaying the “AV System Settings” screen* on this page.

2 Touch **[AV1 Input]**.

Each touch of **[AV1 Input]** changes the setting as follows:

- **iPod:** iPod connected with the USB Interface cable for iPod (CD IU50V)
- **Video:** External video component
- **Off:** No video component is connected.
- Use **AV1 Input** when connecting CD IU50V (sold separately) through the external video component.

Setting video input 2 (AV2)

You can switch this setting according to the connected component.

- This setting applies to RCA inputs (AUDIO INPUT and VIDEO INPUT) on the back of the system.

Customizing preferences

1 Display the “AV System Settings” screen.

- For details, refer to *Displaying the “AV System Settings” screen* on the previous page.

2 Touch [AV2 Input].

Each touch of [AV2 Input] changes the setting as follows:

- **Off:** No video component is connected.
- **EXT:** Pioneer external unit connected with the RCA video cable
- **Video:** External video component

Changing the wide screen mode

1 Display the “AV System Settings” screen.

- For details, refer to *Displaying the “AV System Settings” screen* on the previous page.

2 Touch [Wide Mode].

Each touch of [Wide Mode] changes the setting as follows:

- **Full (full)**
A 4:3 picture is enlarged in the horizontal direction only, enabling you to enjoy a 4:3 TV picture (normal picture) without any omissions.
 - **Cinema (cinema)**
A picture is enlarged by the same proportion as **Full** or **Zoom** in the horizontal direction and by an intermediate proportion between **Full** and **Zoom** in the vertical direction; ideal for a cinema sized picture (wide screen picture) where captions lie outside the frame.
 - **Zoom (zoom)**
A 4:3 picture is enlarged in the same proportion both vertically and horizontally; ideal for a cinema sized picture (wide screen picture).
 - **Normal (normal)**
A 4:3 picture is displayed normally, giving you no sense of disparity since its proportions are the same as that of the normal picture.
- ❑ Different settings can be stored for each video source.

- ❑ The same setting is automatically applied for the following grouping.
 - **DVD-V** and **DivX**
 - **AV1** and **AV2**
 - **EXT1** and **EXT2**
- ❑ When video is viewed in a wide screen mode that does not match its original aspect ratio, it may look strange.
- ❑ Remember that use of this system for commercial or public viewing purposes may constitute an infringement on the author's rights protected by the Copyright Law.
- ❑ The navigation map and the rear view camera picture is always viewed at **Full**.

Setting the rear output

The navigation system's rear output can be used for a full range speaker or subwoofer connection. If you switch **Rear SP** to **Sub. W**, you can connect a rear speaker lead directly to a subwoofer without using an auxiliary amp. Initially, the navigation system is set for a rear full range speaker connection (**Full**).

- ❑ Both rear speaker leads output and RCA rear output are switched simultaneously in this setting. (When you use the product without RCA rear output, this setting only applies to the rear speaker leads.)
- ❑ “**Rear SP**” can be set only when the source is selected to “**Off**”.

1 Display the “AV System Settings” screen.

- For details, refer to *Displaying the “AV System Settings” screen* on the previous page.

2 Touch [Rear SP].

Each touch of [Rear SP] changes the settings as follows:

- **Full**
When no subwoofer is connected to the rear output, select “**Full**”.
- **Sub. W**
When a subwoofer is connected to the rear output, select “**Sub. W**”.

Switching the muting/attenuation timing

You can mute the AV source volume or attenuate the output signal. This setting is invalid for the mute signal that has been received from the MUTE lead connected to the navigation unit. (Even if this setting is "Off", the navigation system will mute or attenuate the audio source volume when the signal is output via MUTE lead.)

1 Display the "AV System Settings" screen.

- ➔ For details, refer to *Displaying the "AV System Settings" screen* on page 168.

2 Touch [Mute].

Each touch of [Mute] changes the settings as follows:

- **Guide/Tel/VR:** The volume is muted or attenuated according to the following conditions.
 - When the navigation outputs the guidance voice.
 - When you use a cellular phone via Blue tooth technology (dialing, talking, in coming call).
 - When the voice recognition mode is activated.
- **Tel/VR:** The volume is muted or attenuated according to the following conditions.
 - When you use a cellular phone via Blue tooth technology (dialing, talking, in coming call).
 - When the voice recognition mode is activated.
- **Off:** The volume does not change.
- AV source volume returns to normal when the corresponding action is ended.

Switching the muting/attenuation level

You can select the muting/attenuation level of "Mute". This setting is also effective for a mute signal that has been received from the MUTE lead connected to the navigation unit.

- This menu is not available when AV source is "Off".

1 Display the "AV System Settings" screen.

- ➔ For details, refer to *Displaying the "AV System Settings" screen* on page 168.

2 Touch [Mute Level].

Each touch of [Mute Level] changes the settings as follows:

- **20dB:** The volume becomes 1/10.
- **10dB:** The volume becomes 1/3.
- **All:** The volume becomes 0.
- When you select "All", no audio adjustments are possible during the sound is turned off.
- When you select "20dB" or "10dB", no audio adjustments are possible during the sound is attenuated.
- AV source volume returns to normal when the corresponding action is ended.
- Even when a mute signal has been received from MUTE lead connected to the navigation unit, navigation voice guidance cannot be attenuated or muted.

Acquiring/Cataloging iPod music information

If you always set the language other than "English" on "Voice Language", this setting is unnecessary.

Unless "VR Catalog Mode" is turned off, this navigation system tries to acquire the information needed to operate iPod with voice commands. It may take a short period of time to transfer the information. Change the setting according to your usage.

The navigation system starts acquiring/cataloging music information (1) when the iPod is connected or when the system boots up while the iPod is connected and (2) when iPod is the selected and displayed AV Source, unless "VR Catalog Mode" is turned off.

Customizing preferences

- ❑ This function is available when “**Change Control Mode**” is set to “**Navi**”.
- ❑ If you do not use iPod, this setting is unnecessary.
- ❑ During transfer, the following iPod operations are not available.
 - Setting the shuffle play for music
 - Displaying the top category menu
 - Switching the operation screen
- ❑ Once the cataloging is completed, you can deactivate “**VR Catalog Menu**” until you update the content/data on iPod. If you update the iPod data, activate “**VR Catalog Menu**” again to transfer the music information and synchronize the music information for voice commands with the data on iPod.
- ❑ After you select “**Off**” in “**VR Catalog Mode**”, the system doesn’t catalog the data on the iPod. In such case, the previously cataloged data are available as voice commands.
- ❑ Once you start the cataloging process, only a few basic voice commands can be used for iPod until the process has completely finished.
- ❑ If unreadable characters are included in the data on your iPod, names or types may not be available as voice commands.

Important Notice regarding Voice Control for iPods

Voice Control for iPods may be limited if cataloging of iPod content is not completed. Cataloging of iPod content only occurs when the system is in “**AV Source**” mode and the “**iPod**” is the selected and displayed “**AV Source**” screen. Cataloging of iPod content will not occur if the system is off, if any other “**AV Source**” is selected (aside from iPod), or if the system is in any other mode (aside from “**AV Source**” mode) such as “**Destination Menu**”, “**Settings Menu**”, “**Phone Menu**” or the map screen. If you wish to use Voice Control for all iPod content, it is recommended that you first connect your iPod, select “**iPod**” as the AV source, and keep the iPod screen displayed until cataloging is completed cataloging of

iPod content should only take a few minutes, and will depend on the size of the content stored on your iPod. A message will be displayed when cataloging is completed.

1 Display the “AV System Settings” screen.

- ☞ For details, refer to *Displaying the “AV System Settings” screen* on page 168.

2 Touch [VR Catalog Menu].

3 Touch [On] or [Off] to activate or deactivate “VR Catalog Mode”.

- Touch [Pause].

The cataloging of iPod stops.

If you want to restart the cataloging of iPod, touch [Restart].

Displaying your DivX VOD registration code

In order to play DivX VOD (video on demand) content on this navigation system, you first need to register the unit with your DivX VOD content provider. You do this by generating a DivX VOD registration code, which you submit to your provider.

- ❑ This feature is available when the selected source is **CD**, **ROM**, **DivX**, or **DVD-V**.

1 Display the “AV System Settings” screen.

- ☞ For details, refer to *Displaying the “AV System Settings” screen* on page 168.

2 Touch [DivX VOD].

Your 8 digit registration code is displayed.

- ❑ Make a note of the code as you will need it when you register with a DivX VOD provider. [■]

Displaying the “AV Sound Settings” screen

1 Press the HOME button to display the “Top Menu” screen.

2 Touch [Settings].

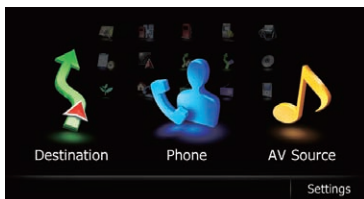

The “Settings Menu” screen appears.

3 Touch [AV Sound].

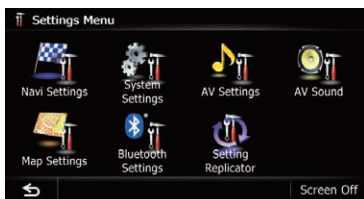

The “AV Sound Settings” screen appears.

- You cannot make adjustments in the following situations:
 - AV source is “Off”.
 - During muting/attenuation
- You cannot select “SLA” when the FM tuner is selected as the AV source.

4 Touch the item that you want to change the setting.

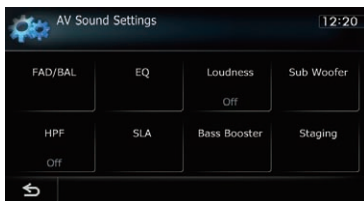

- Touch .

The previous screen returns.

Using balance adjustment

You can select a fader/balance setting that provides an ideal listening environment in all occupied seats.

1 Display the “AV Sound Settings” screen.

- ☞ For details, refer to *Displaying the “AV Sound Settings” screen* on the previous page.

2 Touch [FAD/BAL].

When “Sub. W” is selected in “Rear SP”, “Balance” will be displayed instead of “FAD/BAL” and front/rear speaker balance cannot be adjusted.

- ☞ For details, refer to *Setting the rear output* on page 169.

3 Touch [▲] or [▼] to adjust front/rear speaker balance.

Each time you touch [▲] or [▼], the front/rear speaker balance moves towards the front or the rear.

“Front:15” to “Rear:15” is displayed as the front/rear speaker balance moves from front to rear.

Setting “Front:” and “Rear:” to “0” is correct when using a two speaker system.

4 Touch [◀] or [▶] to adjust left/right speaker balance.

Each time you touch [◀] or [▶], the left/right speaker balance moves towards the left or the right.



“Left:15” to “Right:15” is displayed as the left/right speaker balance moves from left to right.

Using the equalizer

The equalizer lets you adjust equalization to match vehicle interior acoustic characteristics as desired.

Customizing preferences

Recalling equalizer curves

There are seven stored equalizer curves that you can easily recall at any time. Here is a list of the equalizer curves:

Equalizer curve

SuperBass is a curve in which only low pitched sound is boosted.

Powerful is a curve in which low pitched and high pitched sounds are boosted.

Natural is a curve in which low pitched and high pitched sounds are slightly boosted.

Vocal is a curve in which the midrange, which is the human vocal range, is boosted.

Flat is a flat curve in which nothing is boosted.

Custom1 is an adjusted equalizer curve that you create. A separate custom curve can be created for each source.

Custom2 is an adjusted equalizer curve that you create. If you select this curve, the effect is reflected all AV source.

1 Display the “AV Sound Settings” screen.

- For details, refer to *Displaying the “AV Sound Settings” screen* on page 171.

2 Touch [EQ].

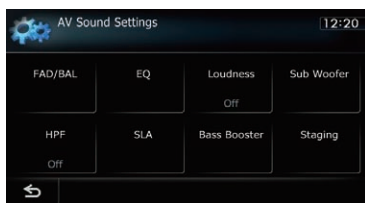

3 Touch the equalizer you want.

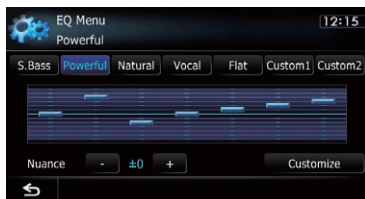

Adjusting the preset equalizer curve effect

You can adjust the effect of the preset equalizer curves.

The following equalizer curves can be adjusted:

- **SuperBass**
- **Powerful**
- **Natural**
- **Vocal**

1 Display the “AV Sound Settings” screen.

- For details, refer to *Displaying the “AV Sound Settings” screen* on page 171.

2 Touch [EQ].

3 Touch the equalizer you want.

4 Touch [+] or [-] next to “Nuance”.

- The level can be adjusted in the range of -6 to +6.
- If “Natural” is selected, the level can be adjusted in the range of -4 to +6.

Adjusting the equalizer curves

You can adjust the currently selected equalizer curve setting as desired. Adjustments can be made with a 7 band graphic equalizer.

The difference between “Custom1” and “Custom2”

- A separate **Custom1** curve can be created for each source. If you make adjustments when a curve **SuperBass**, **Powerful**, **Natural**, **Vocal**, **Flat**, or **Custom1** is selected, the equalizer curve settings will be memorized in **Custom1**.
- A **Custom2** curve can be created common to all sources. If you make adjustments when **Custom2** curve is selected, the **Custom2** curve will be updated.
- The adjusted **Custom1** curve is memorized for each of the source selected, but one curve is shared for the following sources.

**CD, ROM, DVD-V, and DivX
AM and FM
EXT1 and EXT2**

AV1 and AV2 SD and USB

- The different source volume level can be set between **iPod** and **USB**.
- When **"Flat"** is selected, no supplement or correction is made to the sound. This is useful to check the effect of the equalizer curves by switching alternatively between **"Flat"** and a set equalizer curve.

1 Display the "AV Sound Settings" screen.

- ☞ For details, refer to *Displaying the "AV Sound Settings" screen* on page 171.

2 Touch [EQ].

3 Touch one of the keys to select a curve that you want to use as the basis of customizing.

4 Touch [Customize].

5 Touch the frequency that you want to adjust the level.



6 Touch [▲] or [▼] to adjust the level of the equalizer band.

Each time you touch [▲] or [▼], the level of the equalizer band increases or decreases.

Adjusting loudness

Loudness compensates for deficiencies in the low and high sound ranges at low volume.

1 Display the "AV Sound Settings" screen.

- ☞ For details, refer to *Displaying the "AV Sound Settings" screen* on page 171.

2 Touch [Loudness].

Each time you touch [Loudness], the level is selected in the following order:

Off Low Mid High

Using subwoofer output

The navigation system is equipped with a subwoofer output mechanism, which can be turned on or off.

- ☐ This function is not available when **"Sub Woofer"** is **"Off"**.

1 Display the "AV Sound Settings" screen.

- ☞ For details, refer to *Displaying the "AV Sound Settings" screen* on page 171.

2 Touch [Sub Woofer].

3 Touch [On] to turn subwoofer output on.

To turn subwoofer output off, touch [Off].



4 Touch [Reverse] or [Normal] to select the phase of subwoofer output.

5 Touch [+] or [-] next to "Level" to adjust the output level.

"+6" to "-24" is displayed as the level is increased or decreased.

6 Touch [◀] or [▶] next to "Frequency(Hz)" to select cut-off frequency.

Each time you touch [◀] or [▶], cut off frequencies are selected in the following order:
50Hz 63Hz 80Hz 100Hz 125Hz
Only frequencies lower than those in the selected range are output from the subwoofer.

Customizing preferences

Using the high pass filter

When you do not want low sounds from the subwoofer output frequency range to play from the front or rear speakers, activate **HPF** (high pass filter). Only frequencies higher than those in the selected range are output from the front or rear speakers.

1 Display the "AV Sound Settings" screen.

- ➔ For details, refer to *Displaying the "AV Sound Settings" screen* on page 171.

2 Touch [HPF].

Each time you touch [HPF] selects cut off frequencies in the following order:

Off 50Hz 63Hz 80Hz 100Hz 125Hz

Adjusting source levels

SLA (source level adjustment) lets you adjust the volume level of each source to prevent radical changes in volume when switching between sources.

- ❑ Settings are based on the FM tuner volume level, which remains unchanged.

1 Compare the FM tuner volume level with the level of the source you wish to adjust.

2 Display the "AV Sound Settings" screen.

- ➔ For details, refer to *Displaying the "AV Sound Settings" screen* on page 171.

3 Touch [SLA].

4 Touch [+] or [-] to adjust the source volume.

"**+8dB**" to "**-8dB**" is displayed as the source volume is increased or decreased.

The following AV sources are set to the same source level adjustment volume automatically.

- **CD, ROM, DivX**
- **SD and USB**
- **AV1 and AV2**
- **EXT1 and EXT2**

- ❑ The different source volume level can be set between **iPod** and **USB**.

Enhancing bass (Bass Booster)

You can enhance bass sounds that are often muted by driving noise.

1 Display the "AV Sound Settings" screen.

- ➔ For details, refer to *Displaying the "AV Sound Settings" screen* on page 171.

2 Touch [Bass Booster].

3 Touch [+] or [-] to adjust the range from 0 to 6.

Setting the simulated sound stage

You can select the desired effect from various simulated sound stages, such as Music Studio or Dynamic Theater. You can also adjust a listener positioning effect.

Setting a stage that fits your image

1 Display the "AV Sound Settings" screen.

- ➔ For details, refer to *Displaying the "AV Sound Settings" screen* on page 171.

2 Touch [Staging].

3 Touch desired stage setting.

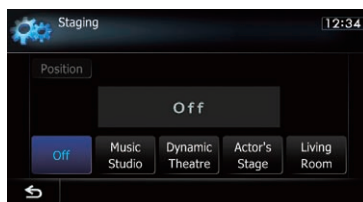

- ❑ "**Living Room**" setting that emphasizes mid range sound hardly has any effect near the maximum volume level.
- ❑ When you set staging to an option other than "**Off**", the high pass filter (**HPF**) setting turns "**Off**".

- ➔ For details, refer to *Using the high pass filter* on the previous page.

Adjusting a position effect

You can select a listener position that you want to make as the center of sound effects.

1 Display the “AV Sound Settings” screen.

- ➔ For details, refer to *Displaying the “AV Sound Settings” screen* on page 171.

2 Touch [Staging].

3 Touch [Position].

4 Touch desired position.

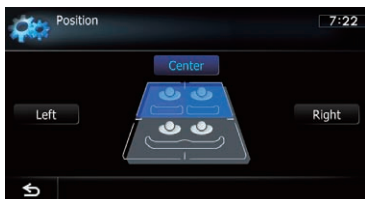

5 Touch [Setting Replicator].

A message confirming whether to update the settings appears.

6 Touch [Yes].

Update starts.

After the settings are updated, a message confirming whether to restart the navigation system appears.

7 Touch [OK].

The navigation system restarts.

Replicating the settings

You can import settings you have made on the utility program AVIC FEEDS which is available separately to the navigation system.

1 Use AVIC FEEDS to replicate the settings and store them on an SD memory card.

2 Insert an SD memory card into the SD card slot.

- ➔ For details of the operation, refer to *Inserting and ejecting an SD memory card* on page 15.

3 Press the HOME button to display the “Top Menu” screen.

4 Touch [Settings].

The “Settings Menu” screen appears.

Turning off the screen

By turning off the backlight of the LCD screen, you can turn off the screen display without turning off the voice guidance.

1 Press the HOME button to display the “Top Menu” screen.

2 Touch [Settings].

The “**Settings Menu**” screen appears.

3 Touch [Screen Off].

The screen is turned off.

- Touch anywhere on the screen to turn it back on.

To Ensure Safe Driving

⚠ CAUTION

For your safety, avoid viewing the screen in the voice operation as much as possible while driving.

If you use voice operation, select **[English]** in **[Voice Language]** of **"Regional Settings"**. If you select other languages, voice operation will not be available.



Basics of Voice Operation

Your Pioneer navigation system uses the latest in voice recognition technology. You can use voice commands to operate many of its functions. This chapter describes where you can use voice commands, and also what commands the system accepts.

- ❑ This function is not available while the cataloging of iPod is created.

Flow of voice operation

You can start voice operation any time even when the map screen is displayed or AV is operating. (Some operations are not available.) The basic steps of voice operations are as follows.

- Switch the screen to map screen or AV operation screen.



- Press the button to activate voice operations.



- Speak a command into the microphone after the beep. When the command is recognized, the navigation system displays next options on the screen, and pronounces it in some cases.



- Repeat previous step as necessary.



- The requested operation will be carried out.

- ❑ The voice operation may not be operable for a minute after the navigation system has booted up.
- ❑ Voice operation will be activated 30 seconds after the map screen is displayed. If the button does not respond, display the disclaimer screen and then touch **[OK]**. The map screen is displayed.



Starting voice operation

- **Press the button when the map screen or the AV operation screen is displayed.**

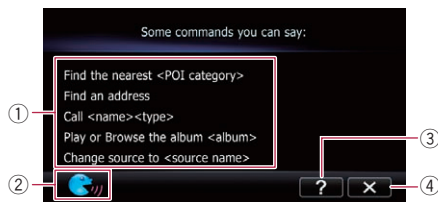
The voice operation screen appears.



Operating Your Navigation System with Voice

- ① Voice help menu:
Displays a list of commands for voice operation.
- ② Voice operation condition indicator:
When  is indicated, the navigation system can recognize your voice commands.
- ③ :
You can listen to the brief operating instruction.
- ④ :
cancels voice operation.
You can cancel the voice operation feature at any time by saying "Cancel". After you cancel voice operations, the display returns to the screen displayed before the voice operation screen appeared.

How to use the voice operation

Searching for a location by address

In this example, you want to search for a location by address and set it as your destination.

- When the list of candidates with number appears, say the number that you want to select.
When you select the entry next to "1", say "Number One".
- If there are multiple items that correspond to the name you gave, the list screen appears. In this case, touch the item you want to select from the list.

1 Press the MODE button to display the map screen or the AV operation screen.

2 Press the  button to activate voice operations.

A list of commands for voice operation appears. After a message, the beep indicates that the system is ready to accept your voice command. Say a command after this beep.

3 Say "I need directions".

A message prompting you to select a search by address or by POI appears.

4 Say "Find an address".

A message prompting the next operation is given.

5 Say the state name that you want to set to your destination.

6 Say the city name that you want to set to your destination.

7 Say the street name that you want to set to your destination.

8 Say the house number that you want to set to your destination.

Your navigation system sets the route to your destination, and the map of your surroundings appears.

- If you say "Just go there", the navigation system sets the route to the representative location of the city or the street.

Search for POI in vicinity

In this example, you want to search for a POI and set it as your destination.

- When the list of candidates with number appears, say the number that you want to select.
When you select the entry next to "1", say "Number One".
- If there are multiple items that correspond to the name you gave, the list screen appears. In this case, touch the item you want to select from the list.

1 Press the MODE button to display the map screen or the AV operation screen.

2 Press the  button to activate voice operations.

A list of commands for voice operation appears. After a message, the beep indicates that the system is ready to accept your voice command. Say a command after this beep.

3 Say "I need directions".

A message prompting you to select a search by address or by POI appears.

4 Say “Point of interest”.

The list of POI categories appears.

5 Say the category that you want to set to your destination.

The list of candidates with number appears.

6 Say the number that you want to select.

Your navigation system sets the route to your destination, and the map of your surroundings appears.

Calling the entry on “Contacts”

A method for dialing the entry named “Nancy” is described here along with an operational example.

1 Press the  button to activate voice operations.**2 Say “Call Nancy” to make a call.**

A message confirming whether to dial appears.

3 Say “Yes”.

Dialing starts.

Operating iPod by voice

You can play music using voice operation from the iPod connected to the navigation system.

- To use the content/data on the iPod for voice operation, transfer the data to this system first.

➔ For details, refer to *Acquiring/Cataloging iPod music information* on page 170.

Examples of voice operation of the iPod are shown below. (A method for playing the album title named “Pioneer” is described here, along with an operational example.)

1 Press the  button to activate voice operations.**2 Say “Change Source” to display the AV source selection screen.****3 Say “iPod” on the selection screen to switch the AV source to iPod.**

- Touching the item on the screen also enables you to select the desired AV source.

4 Press the  button to activate voice operations.**5 Say “Play the album Pioneer” to playback the album name “Pioneer”.**

If the command is recognized properly, playback starts from the first song of “Pioneer”. 

Operating Your Navigation System with Voice

Available Basic Voice Commands

The navigation system can also recognize the words in the following list.

- Terms written in italics are voice commands.

Basic commands

Voice commands and operations

Back → The previous screen returns.

Cancel → Cancels the voice operation.

Help → Outputs the brief operating instruction by voice.

Next page, Previous page → Switches the page.

Last page, First page → Switches to the last or first page.

Voice operation for the iPod

For <Artist name>, <Album name>, <Playlist name>, <Genre name> shown on the following chart, say the name their name in the iPod.

- Playback of iPod movies is not available using voice commands.

Voice commands and operations

Shuffle play → Plays all songs randomly.

Resume → Resumes the song or the video currently playing .

Pause → Pauses the song or the video currently playing .

Next song → Plays the next song.

Previous song → Plays the previous song or return to the beginning of the song currently playing.

Play songs → Starts playback from the top of "**Songs**".

Play artists → Displays the artist list → Say the artist name that you want to play.

Play the artist <Artist name> → Starts playback from the top of the selected artist.

Play albums → Displays the album list → Say the album name that you want to play.

Play the album <Album name> → Starts playback from the top of the selected album.

Play playlists → Displays the playlist → Say the playlist that you want to play.

Play the playlist <Playlist name> → Starts playback from the top of the selected playlist.

Play genres → Displays the genre list → Say the genre that you want to play.

Play the genre <Genre name> → Starts playback from the top of the selected genre.

Browse artists → Displays the artist list together with sub screen to continue the voice operation. → Say the desired voice commands.

Browse the artist <Artist name> → Displays the album list of the selected artist together with sub screen to continue the voice operation. → Say the desired voice commands.

Browse albums → Displays the album list together with sub screen to continue the voice operation. → Say the desired voice commands.

Browse the album <Album name> → Displays the song list of the selected album together with sub screen to continue the voice operation. → Say the desired voice commands.

Voice commands and operations

Browse playlists → Displays the playlist together with sub screen to continue the voice operation. → Say the desired voice commands.

Browse the playlist <Playlist name> → Displays the song list of the selected playlist together with sub screen to continue the voice operation. → Say the desired voice commands.

Browse genre → Displays the genre list together with sub screen to continue the voice operation. → Say the desired voice commands.

Browse the genre <Genre name> → Displays the song list of the selected genre list together with sub screen to continue the voice operation. → Say the desired voice commands.

Play more music artist → Plays the songs related to the currently playing artist.

Play more music album → Plays the songs related to the currently playing album.

Play more music genre → Plays the songs related to the currently playing genre.

Next page, Previous page → Displays the previous or next page of the selection list. (*1)

First page, Last page → Displays the first or last page of the the selection list. (*1)

(*1) The voice commands is available only when the selection list is displayed.

Voice operation for AV source (other than iPod)**AV source selection****Voice commands and operations**

Change Source to DISC → Switches the AV source to **Disc**.

Change Source to FM → Switches the AV source to **FM**.

Change Source to AM → Switches the AV source to **AM**.

Change Source to XM Satellite Radio → Switches the AV source to **XM**.

Change Source to SIRIUS Satellite Radio → Switches the AV source to **SIRIUS**.

Change Source to "HD Radio" → Switches the AV source to **Digital Radio**.

Change Source to SD Media → Switches the AV source to **SD**.

Change Source to USB → Switches the AV source to **USB**.

Change Source to iPod → Switches the AV source to **iPod**.

Change Source to Bluetooth Audio → Switches the AV source to **Audio**.

Built-in DVD drive, external storage device (USB, SD)**Voice commands and operations**

Shuffle play → Plays all songs randomly.

Pause → Pauses the track or file currently playing.

Resume → Resumes the track or file currently playing.

Next song → Plays the next track or file.

Previous song → Plays the previous track or file, or returns to the beginning of the track or file currently playing.

Operating Your Navigation System with Voice

Voice commands related to hands-free phoning

- ❑ You can make a phone call by voice dialing if the cellular phone featuring Bluetooth wireless technology is being paired with the navigation system.
- ❑ For <entry's name> shown on the following chart, say the name of the entry stored in "Contacts".
- ❑ For <phone number> shown on the following chart, say the desired phone number.

Voice commands and operations

Call <entry's name> → Makes a call to the entry (*2).

Call <entry's name> general → Displays the message confirming whether to dial → Say *Yes* → Dials the general phone number of the entry (*3).

Call <entry's name> mobile → Displays the message confirming whether to dial → Say *Yes* → Dials the cellular phone number of the entry (*3).

Call <entry's name> home → Displays the message confirming whether to dial → Say *Yes* → Dials the home phone number of the entry (*3).

Call <entry's name> work → Displays the message confirming whether to dial → Say *Yes* → Dials the office phone number of the entry (*3).

Call <entry's name> other → Displays the message confirming whether to dial → Say *Yes* → Dials the other phone number of the entry (*3).

Call <phone number> → Displays the message confirming whether to dial → Say *Yes* → Dials the phone number.

Make a call → Say the phone number you want to call → Displays the message confirming whether to dial → Say *Yes* → The system starts dialing to the number.

Make a call → Say the name of entry stored on "Contacts" you want to call → Displays the message confirming whether to dial → Say *Yes* → The system starts dialing to the number (*2).

List outgoing calls → Display the list of recent outgoing calls ("Dialed Calls") to select the number and call (*4).

List recent calls → *Incoming calls* → Display the list of recently received calls ("Received Calls") to select the number and call (*4).

List recent calls → *Outgoing calls* → Display the list of recent outgoing calls ("Dialed Calls") to select the number and call (*4).

List recent incoming calls → Display the list of recently received calls ("Received Calls") to select the number and call (*4).

Find the nearest → Displays the category list → Say the category that you want to set to your destination → Displays the list of candidates with number → *Show me details for <the number that you want to select>* → *Call* → Dialing starts.

(*2) If the entry has multiple phone number data, selection list may appear. In such case, say the type of phone number.

(*3) If there is no corresponding type on the entry, the system may suggest you other phone numbers of the entry. In such case, say the type of phone number.

(*4) Touching the item on the screen also enables you to select the desired list.



Tips for Voice Operation

For your voice commands to be correctly recognized and interpreted, ensure that conditions are suitable for recognition.

Close the vehicle windows

Please note that wind through the vehicle window or miscellaneous noise from outside the vehicle can interfere with voice operation.

Position the microphone carefully

For optimum pick up, the microphone should be fixed at a suitable distance directly in front of the driver.

Pause before giving a command

Speaking too soon may cause the recognition to fail.

Pronounce your commands carefully

Speak slowly, deliberately, and clearly. 

Other functions

Setting the anti-theft function

You can set a password for the navigation system. If the back up lead is cut after the password is set, the navigation system prompts for the password at the time of next boot up.

Setting the password

1 Press the HOME button to display the "Top Menu" screen.

2 Touch [Settings].

The "Settings Menu" screen appears.

- This can also be operated using the "Short cut Menu" screen.

3 Touch Area1, followed by Area2, and then touch and hold Area3.

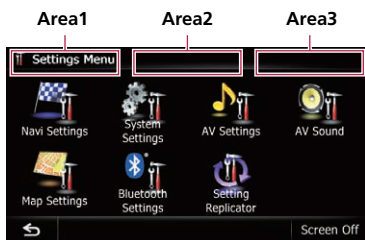

4 Touch [Set Password].

The password setting screen appears.

5 Enter the password you want to set.

- 5 to 16 characters can be entered for a password.

6 Touch [OK].

7 Reenter the password to confirm the setting.

8 Touch [OK].

Password protection is applied.

- If you want to change the password currently set, enter the current password and then enter the new one.

Entering the password

On the password input screen, you must enter the current password. If you enter an incorrect password three times, the screen is locked and operations using touch panel keys are disabled.

1 Enter the password.

2 Touch [OK].

The message "The unit has been locked because an invalid password was entered three times. Turn ACC off and on, and enter your password." appears if you entered the correct password and the navigation system is unlocking.

Deleting the password

The current password can be deleted.

1 Press the HOME button to display the "Top Menu" screen.

2 Touch [Settings] on the "Top Menu".

3 Touch Area1, followed by Area2, and then touch and hold Area3.

4 Touch [Clear password].

The password setting screen appears.

5 Enter the current password.

6 Touch [OK].

7 Touch [Yes].

The message for deletion appears and then the current password is deleted.

Forgotten password

Contact the nearest authorized Pioneer Service Station.

Returning the navigation system to the default or factory settings

You can return settings or recorded content to the default or factory settings. There are some methods to clear user data, and the situations and the cleared content are different for each method. For information regarding the content that is cleared by each method, see the list presented later.

Method 1: Remove the vehicle battery

This transforms the system into the same state as when the navigation system is uninstalled.

Method 2: Restore Factory Settings

This clears some items in the “Navi Settings” menu.

➤ For details, refer to **Restore Factory Settings** on page 188.

Method 3: Touch [Clear user information] on the “Select Items to Reset” screen.

➤ For details, refer to *Displaying the “Select Items to Reset” screen* on page 188.

Method 4: Touch [Reset] on the “Select Items to Reset” screen.

➤ For details, refer to *Displaying the “Select Items to Reset” screen* on page 188.

Other functions

Setting items to be deleted

The items to be deleted vary depending on the reset method. The items listed in the following table return to the default or factory settings.

- Almost all items not listed below will be retained. However, some of the items to be returned to their default values are not listed if the setting value can be easily recovered by user, such as the last map scale, the last status of AV operation screen, etc.

○: The setting will be retained.

- ✓: The setting will be cleared and returned to the default or factory settings.

Navigation functions	Method 1	Method 2	Method 3	Method 4
Map function	View mode and scale setting on the map		✓	✓
	Direction of the map		✓	✓
	Last cursor position on the map screen	✓	✓	✓
Route Setting	Current route	✓	✓	✓
	Guidance state of the current route		✓	✓
	Vehicle position information		✓	✓
	Options	✓	✓	✓
Others	Keyboard	✓	✓	✓
	Learnt data used in Learning Route	✓	✓	✓
Destination	Point registered in Favorites		✓	
	History		✓	
Map Settings	View Mode		✓	✓
	Other settings	✓	✓	✓
Navi Settings	3D Calibration Status			
	Drive Log Settings		✓	
	Demo Mode	✓	✓	✓
	Set Home		✓	
	Modify Current Location		✓	✓
	Other settings	✓	✓	✓
System Settings	Program Language, Voice Language		✓	✓
	Time		✓	✓
	Back Camera	✓		
	Other settings	✓	✓	✓
Bluetooth Settings	All settings (*1)	✓	✓	✓

Navigation functions		Method 1	Method 2	Method 3	Method 4
Phone Menu	All settings (*1)		✓	✓	✓
Other functions	Anti theft password				

(*1) All stored data of 5 users is deleted.

AV functions		Method 1	Method 2	Method 3	Method 4
Volume		✓			
AV Settings	Wide Mode, Mute, VR Catalog Menu		✓	✓	✓
	Other settings	✓			
AV Sound	All settings	✓			
CD, ROM, DVD-V, DivX, FM, AM, Audio	All settings (*2)	✓			
SD, USB	All settings (*2)	✓		✓	
Other functions	Picture Adjustment	✓			
	Tilt	✓			

(*2) All settings including the setting on the "Function" menu are deleted.

Restore Factory Settings

- ❑ Be sure to read "Setting items to be deleted" before you perform this operation.

1 Display the "System Settings" screen.

- ➔ For details, refer to *Displaying the "System Settings" screen* on page 161.

2 Touch [Restore Factory Settings].

The message confirming whether to restore the settings appears.

3 Touch [Yes].

Displaying the "Select Items to Reset" screen

- ❑ Be sure to read "Setting items to be deleted" before you perform this operation.

1 Park your vehicle in a safe place and apply the parking brake.

2 Turn the ignition switch off and back on.

The navigation system restarts, and the splash screen appears.

3 Press and hold the MODE button and the TRK (◀) button while splash screen appears.

- ❑ For users of AVIC Z120BT, press the MODE button and the TRK (◀◀) button.

The "Select Items to Reset" screen appears.

4 Touch [Clear user information] or [Reset].

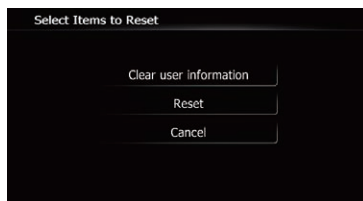

The message confirming whether to erase the data appears.

5 Touch [Yes].

The recorded contents are cleared. ❑

Appendix

Troubleshooting

If you have problems operating your navigation system, refer to this section. The most common problems are listed below, along with likely causes and solutions. If a solution to your problem cannot be found here, contact your dealer or the nearest authorized Pioneer service facility.

Problems with the navigation screen

Symptom	Cause	Action (Reference)
The power doesn't turn on. The navigation system doesn't operate.	Leads and connectors are incorrectly connected.	Confirm once more that all connections are correct.
	The fuse is blown.	Rectify the reason for the fuse blowing, then replace the fuse. Be very sure to install a correct fuse with the same rating.
	Noise and other factors are causing the built in microprocessor to operate incorrectly.	Park your vehicle in a safe place, and turn off the engine. Turn the ignition key back to Acc off. Then start the engine again, and turn the power to the navigation system back on.
You cannot position your vehicle on the map without a significant positioning error.	The GPS antenna is in an unsuitable location.	The quality of signals from the GPS satellites is poor, causing reduced positioning accuracy. Check the GPS signal reception and the position of the GPS antenna if necessary.
	Obstacles are blocking signals from the satellites.	The quality of signals from the GPS satellites is poor, causing reduced positioning accuracy. Check the GPS signal reception and the position of the GPS antenna if necessary, or continue driving until reception improves. Keep the antenna clear.
	The position of satellites relative to your vehicle is inadequate.	The quality of signals from the GPS satellites is poor, causing reduced positioning accuracy. Continue driving until reception improves.
	Signals from the GPS satellites have been modified to reduce accuracy. (GPS satellites are operated by the US Department of Defense, and the US government reserves the right to distort positioning data for military reasons. This may lead to greater positioning errors.)	The quality of signals from the GPS satellites is poor, causing reduced positioning accuracy. Wait until reception improves.
	If a vehicle phone or cellular phone is used near the GPS antenna, GPS reception may be lost temporarily.	The quality of signals from the GPS satellites is poor, causing reduced positioning accuracy. When using a cellular phone, keep the antenna of the cellular phone away from the GPS antenna.

Appendix

Symptom	Cause	Action (Reference)
You cannot position your vehicle on the map without a significant positioning error.	Something covers the GPS antenna.	Do not cover the GPS antenna with spray paint or vehicle wax, because this may block the reception of GPS signals. Snow buildup can also degrade the signals.
	Signals from the vehicle's speed pulse are not being picked up properly.	Check that the cables are properly connected. If necessary, consult the dealer that installed the system.
	The navigation system may not be mounted securely in your vehicle.	Check that the navigation system is securely mounted and, if necessary, consult the dealer that installed the system.
	The navigation system is installed with an extreme angle exceeding the installation angle limitations.	Confirm the installation angle. (The navigation system must be installed within the allowed installation angle. For details, refer to Installation Manual.)
	Indication of the position of your vehicle is misaligned after a U turn or reversing.	Check whether or not the reverse gear signal input lead (violet) is connected properly. (The navigation system works properly without the lead connected, but positioning accuracy will be adversely affected.)
"Eco Graph" is not available.	The navigation system is unable to obtain past average fuel mileage data, so "Eco Graph" cannot be displayed.	Drive about 6 miles (10 km) on a road without obstructions. Then park your vehicle in a safe place, turn off the navigation system and turn the power to the navigation system back on.
The map color does not switch automatically between daytime and nighttime.	"Day/Night Display" is set to "Day".	Check "Day/Night Display" setting and make sure "Automatic" is selected. (Page 159)
	The orange/white lead is not connected.	Check the connection.
The screen is too bright.	Picture quality adjustment of the display is not correct.	Adjust the picture quality. (Page 167)
The display is very dim.	The vehicle's light is turned ON, and "Automatic" is selected on "Day/Night Display".	Read about "Day/Night Display" setting and, if desired, select "Day". (Page 159)
	Picture quality adjustment of the display is not correct.	Adjust the picture quality. (Page 167)
No sounds of AV source are produced. The volume level will not rise.	The volume level is low.	Adjust the volume level.
	The attenuator or mute is on.	Turn the attenuator or mute off.
	A speaker lead is disconnected.	Check the connection.
The volume of navigation guidance and beeps cannot be adjusted.	VOL (+/ -) button is used to adjust the volume.	Turn the volume up or down using [Volume] on the " System Settings " menu. (Page 163)
The person on the other end of the phone call cannot hear the conversation due to an echo.	The voice from the person on the other end of the phone call is output from the speakers and then picked up by the microphone again, creating an echo.	Use the following methods to reduce the echo: Lower the volume on the receiver Have both parties pause slightly before speaking



Appendix

Symptom	Cause	Action (Reference)
There's no picture.	The parking brake cord is not connected.	Connect the parking brake cord, and apply the parking brake.
	The parking brake is not applied.	Connect the parking brake cord, and apply the parking brake.
	The backlight of the LCD panel is turned off.	Turn on the backlight. (Page 177)
Rear display picture disappears.	The source disc being listened to in the navigation system has been ejected.	Before ejecting the disc, switch the source. This problem may occur when certain connection methods are used.
	There is a problem with the "Rear display", for example a faulty wiring connection.	Check the "Rear display" and its connection.
	An AV source that cannot output to the rear display is selected.	Select an appropriate AV source.
Nothing is displayed and the touch panel keys cannot be used.	The setting for the rear view camera is incorrect.	Select the appropriate setting for the rear view camera.
	The shift lever was placed in [R] when the rear view camera was not connected.	Select the correct polarity setting for "Back Camera". (Page 164)
There is no response when the touch panel keys are touched, or a different key responds.	The touch panel keys deviate from the actual positions that respond to your touch for some reason.	Perform touch panel calibration. (Page 165)
The external storage device (USB, SD) cannot be used.	The USB storage device has been removed immediately after plugging it.	Park your vehicle in a safe place, and turn off the engine. Turn the ignition key back to Acc off. Then start the engine again, and turn the power to the navigation system back on.

Problems in the AV screen

Symptom	Cause	Action (Reference)
CD or DVD playback is not possible.	The disc is inserted upside down.	Insert the disc with the label upward.
	The disc is dirty.	Clean the disc.
	The disc is cracked or otherwise damaged.	Insert a normal, round disc.
	The files on the disc are an irregular file format.	Check the file format.
	The disc format cannot be played back.	Replace the disc.
	The loaded disc is a type this system cannot play.	Check what type of disc it is. (Page 204)
The screen is covered by a caution message and the video cannot be shown.	The parking brake lead is not connected or applied.	Connect the parking brake lead correctly, and apply the parking brake.
	The parking brake interlock is activated.	Park your vehicle in a safe place and apply the parking brake.

Appendix

Symptom	Cause	Action (Reference)
No video output from connected equipment.	"AV1 Input" or "AV2 Input" setting is incorrect.	Correct the settings. (Page 145)
No video output from connected iPod.	The connection of the USB interface cable for iPod is incorrect.	Connect both the USB plug and the RCA cable side. (If only one of these connection has been made, the iPod will not work properly.) (Page 19)
The audio or video skips.	The navigation system is not firmly secured.	Secure the navigation system firmly.
No sounds are produced.	Cables are not connected correctly.	Connect the cables correctly.
The volume level will not rise.	The system is performing still, slow motion, or frame by frame playback with DVD Video.	There is no sound during still, slow motion, or frame by frame playback with DVD Video.
	The system is paused or performing, fast reverse or forward during the disc playback.	For the media other than music CD (CD DA), there is no sound on fast reverse or forward.
The icon  is displayed, and operation is not possible.	The operation is not compatible with the video configuration.	This operation is not possible. (For example, the DVD playing does not feature that angle, audio system, subtitle language, etc.)
The picture stops (pauses) and the navigation system cannot be operated.	The reading of data is impossible during disc playback.	After touching  once, start playback once more.
The picture is stretched, with incorrect aspect ratio.	The aspect setting is incorrect for the display.	Select the appropriate setting for that image. (Page 169, Page 107)
A parental lock message is displayed and DVD playback is not possible.	Parental lock is on.	Turn parental lock off or change the level. (Page 108)
Parental lock for DVD playback cannot be canceled.	The code number is incorrect.	Input the correct code number. (Page 108)
Playback is not with the audio language and subtitle language settings selected in "DVD/DivX® Setup".	The DVD playing does not feature dialog or subtitles in the language selected in "DVD/DivX® Setup".	Switching to a selected language is not possible if the language selected in "DVD/DivX® Setup" is not recorded on the disc. (Page 107)
The picture is extremely unclear/distorted and dark during playback.	The disc features a signal to prohibit copying. (Some discs may have this.)	Since the navigation system is compatible with the copy guard analog copy protect system, the picture may suffer from horizontal stripes or other imperfections when a disc with that kind of protection signal is viewed on some displays. This does not mean the navigation system is malfunctioning.
iPod cannot be operated.	The iPod is frozen.	<ul style="list-style-type: none"> Reconnect the iPod with the USB interface cable for iPod. Update the iPod software version.
	An error has occurred.	<ul style="list-style-type: none"> Reconnect the iPod with the USB interface cable for iPod. Park your vehicle in a safe place, and turn off the engine. Turn the ignition key back to Acc off. Then start the engine again, and turn the power to the navigation system back on. Update the iPod software version.

Appendix

Problems with the phone screen

Symptom	Cause	Action (Reference)
Dialing is not possible because the touch panel keys for dialing are inactive.	Your phone is out of range for service.	Retry after re entering the range for service.
	The connection between the cellular phone and the navigation system cannot be established now.	Perform the connection process.

If the screen becomes frozen...

Park your vehicle in a safe place, and turn off the engine. Turn the ignition key back to Acc off. Then start the engine again, and turn the power to the navigation system back on.



Appendix

Messages and how to react to them

The following messages may be displayed by your navigation system. Refer to the table below to identify the problem, then take the suggested corrective action.

There are occasions when you may see error messages other than those shown here. In such a case, follow the instructions given on the display.

Messages for navigation functions

Message	Cause	Action (Reference)
System detected improper connection of Parking Brake lead. Please check your configuration for safety. Please see Operation Manual for more information regarding safe operation.	Parking brake lead is incorrectly connected.	Confirm once more that their connections are correct.
Route calculation was not possible.	Route calculation has failed because of a malfunction in map data, software, or hardware.	<ul style="list-style-type: none"> • Change the destination. • Consult the Pioneer Local dealer if this message persists.
Route calculation not possible. Destination too far.	The destination is too far.	Set a destination closer to the starting point.
Route calculation not possible. Destination too close.	The destination is too close.	Set a destination farther from the starting point.
Route calculation not possible. Navigation cannot be provided around destination or starting point.	The destination, waypoint(s), or starting point are in an area where no road exists (e.g. a mountain) and the route calculation is impossible.	<ul style="list-style-type: none"> • Set a destination and waypoint(s) on roads. • Reset the destination after you drive the vehicle to any road.
Route to destination cannot be calculated.	The destination or waypoint(s) are in an isolated island, etc. without a ferry and the route calculation is impossible. If there is no road connected to your starting point or destination, this message will appear.	Change the destination.
Failed to create route profile	In rare cases, a route calculation error may occur.	<ul style="list-style-type: none"> • Retry. • Consult the Pioneer Local dealer if this message persists.
No picture folder. Save jpeg file to /Pictures/ folder	Cannot load the image because "Pictures" folder is not found in the inserted external storage device.	Use appropriate data and store it correctly. (Page 164)
	"Pictures" folder exists on the SD memory card but there is no loadable data in the folder.	Use appropriate data and store it correctly. (Page 164)
Data Read error.	Failed to read the data for some reason.	Use appropriate data and store it correctly. (Page 164)
The file is corrupt	The data is damaged or an attempt was made to set an image file that was not made to specifications as the splash screen.	Use appropriate data and store it correctly. (Page 164)

Appendix

Message	Cause	Action (Reference)
Connection failed.	The cellular phone's Bluetooth wireless technology is turned off.	Activate the target phone's Bluetooth wireless technology.
	The cellular phone is paired (connected) with another device.	Cancel the pairing (connection) and retry.
	Rejection has been received from the cellular phone.	Operate the target phone and accept the connection request from the navigation system. (Furthermore, check the connection settings on your cellular phone.)
	The target cellular phone cannot be found.	Check whether your cellular phone is activated and, whether the distance to your cellular phone is not too far.
Could not find any available phone.	No available phone exists in the surroundings when the system searches for connectable cellular phones featuring Bluetooth wireless technology.	<ul style="list-style-type: none"> • Activate the target phone's Bluetooth wireless technology. • Check whether your cellular phone is activated and, whether the distance to your cellular phone is not too far.
Registration failed.	The cellular phone's Bluetooth wireless technology is turned off during the registration step.	Keep turning the target phone's Bluetooth wireless technology on during the registration.
	Rejection by the cellular phone has received.	Operate the target phone and accept the registration request from the navigation system. (Furthermore, check the connection settings on your cellular phone.)
	Registration step has failed for some reason.	Retry the registration and if the registration still fails, try registering using your cellular phone.



Appendix

Messages for audio functions

When problems occur with AV source playback, an error message appears on the display. Refer to the table below to identify the problem, then take the suggested corrective action. If the error persists, record the error message and contact your dealer or your nearest Pioneer service center. The messages in “()” will appear on the “Rear display”.

Built-in DVD drive

Message	Cause	Action (Reference)
Reading error (ERROR-02-XX)	Dirty	Clean the disc.
	Scratched disc	Replace the disc.
	The disc is loaded upside down	Check that the disc is loaded correctly.
Playback error. Please remove the disc.	Electrical or mechanical	<ul style="list-style-type: none"> • Replace the disc. • Set the ACC to off and then set it to on again.
Region code cannot be matched (DIFFERENT REGION DISC)	The disc does not have the same region number as the navigation system.	Replace the DVD Video with one bearing the correct region number.
Unreadable disc	This type of disc cannot be played by the navigation system.	Replace the disc with one the navigation system can play. (Page 207, Page 223)
Playback error due to irregular temperature. Please remove the disc. (THERMAL PROTECTION IN MOTION)	The temperature of the navigation system is out of the normal operating range.	Wait until the unit's temperature returns to within normal operating limits.
Tracks that cannot be played back will be skipped (FILE SKIPPED)	Files that are protected by digital rights management (DRM).	The protected files are skipped.
Cannot play back all tracks (PROTECTED DISC)	All the files on the inserted disc are secured by DRM.	Replace the disc.
Flash writing error. Impossible to write on the flash. (CAN NOT SAVE DATA)	The playback history for VOD contents cannot be saved for some reason.	<ul style="list-style-type: none"> • Retry. • If the message appears frequently, consult your dealer.
Authorization Error (AUTHORIZATION ERROR)	The device does not match the device registered with the VOD provider. VOD content cannot be played back.	Check whether this device has been registered with the VOD provider.
Cannot play back HD file (FILE NOT PLAYABLE-HIGH DEF)	High definition (HD) DivX video cannot be played.	Create playable one and retry.

SD/USB/iPod

Message	Cause	Action (Reference)
Tracks that cannot be played back will be skipped	Files that are protected by digital rights management (DRM).	The protected files are skipped.
	This type of file cannot be played by this unit.	Replace it with the playable file. (Page 207, Page 223)

Appendix

Message	Cause	Action (Reference)
Cannot play back all tracks	All the files on the inserted external storage device are secured by DRM.	Store playable files.
	All of the files cannot be played by this unit.	Replace it with the playable file. (Page 207, Page 223)
USB flash drive was disconnected for device protection. Do not connect this USB flash drive to the unit. To restart USB, restart the unit.	The USB connector or USB cable is short circuited.	Confirm that the USB connector or USB cable is not caught in something or damaged.
	The connected USB storage device consumes more than 500 mA (maximum allowable current).	Disconnect the USB storage device and do not use it. Turn the ignition switch to off, then to ACC or on and then connect the compliant USB storage device.
	The USB interface cable for iPod is short circuited.	Confirm that USB interface cable for iPod or USB cable is not caught in something or damaged.
Authorization failure. iPod is not connected.	The iPod is not compatible with this navigation system.	Use an iPod of a compatible version.
	Communication failure	<ul style="list-style-type: none"> • Disconnect the cable from iPod. Once iPod main menu is displayed, connect the cable again. • If the message appears frequently, consult your dealer.



Appendix

Positioning technology

Positioning by GPS

The Global Positioning System (GPS) uses a network of satellites orbiting the Earth. Each of the satellites, which orbit at a height of 21 000 km, continually broadcasts radio signals giving time and position information. This ensures that signals from at least three can be picked up from any open area on the earth's surface.

The accuracy of the GPS information depends on how good the reception is. When the signals are strong and reception is good, GPS can determine latitude, longitude and altitude for accurate positioning in three dimensions. But if signal quality is poor, only two dimensions, latitude and longitude, can be obtained and positioning errors are somewhat greater.

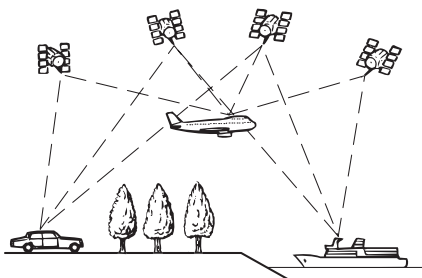

Positioning by dead reckoning

The built in sensor in the navigation system also calculates your position. The current location is measured by detecting driving distance with the speed pulse, the turning direction with the gyro sensor and inclination of the road with the G sensor.

The built in sensor can even calculate changes of altitude, and correct the discrepancies in the distance traveled caused by driving along winding roads or up slopes.

If you use this navigation system with connecting the speed pulse, the system will become more accurate than no connection of speed

pulse. So you connect the speed pulse without fail to get the accuracy of positioning.

- ❑ The position of the speed detection circuit vary depending on the vehicle model. For details, consult your authorized Pioneer dealer or an installation professional.
- ❑ Some types of vehicles may not output a speed signal while driving at just a few kilometers per hour. In such a case, the current location of your vehicle may not be displayed correctly while in traffic congestion or in a parking lot.

How do GPS and dead reckoning work together?

For maximum accuracy, your navigation system continually compares GPS data with your estimated position as calculated from the data of built in sensor. However, if only the data from the built in sensor is available for a long period, positioning errors are gradually compounded until the estimated position becomes unreliable. For this reason, whenever GPS signals are available, they are matched with the data of the built in sensor and used to correct it for improved accuracy.

- ❑ If you use chains on your wheels for winter driving or put on the spare wheel, errors may suddenly increase because of difference in wheel diameter. Initialize the sensor status and it may recover the accuracy to normal condition.
 - ➔ For details, refer to *Clearing status* on page 149.

Appendix

Map matching

As mentioned, the positioning systems used by this navigation system are susceptible to certain errors. Their calculations may, on occasion, place you in a location on the map where no road exists. In this situation, the processing system understands that vehicles travel only on roads, and can correct your position by adjusting it to a nearby road. This is called map matching.

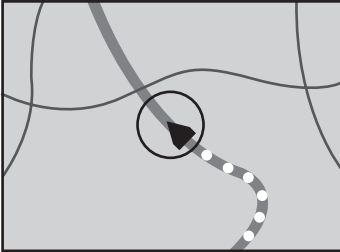

With map matching

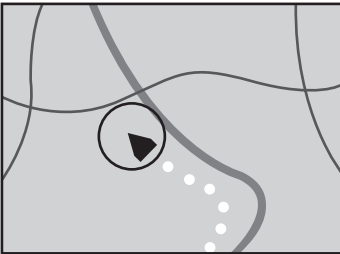

Without map matching

Handling large errors

Positioning errors are kept to a minimum by combining GPS, dead reckoning and map matching. However, in some situations, these functions may not work properly, and the error may become bigger.

When positioning by GPS is impossible

- GPS positioning is disabled if signals can not be received from more than two GPS satellites.
- In some driving conditions, signals from GPS satellites may not reach your vehicle. In this case, it is impossible for the system to use GPS positioning.



In tunnels or enclosed parking garages

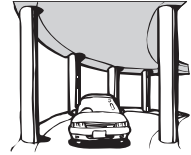

Under elevated roads or similar structures



When driving among high buildings



When driving through a dense forest or tall trees

- If a car phone or cellular phone is used near the GPS antenna, GPS reception may be lost temporarily.
- Do not cover the GPS antenna with spray paint or car wax, because this may block the reception of GPS signals. Snow buildup can also degrade the signals, so keep the antenna clear.
- ☐ If a GPS signal has not been received for a long time, your vehicle's actual position and the current position mark on the map may diverge considerably or may not be up dated. In such case, once GPS reception is restored, accuracy will be recovered.

Appendix

Conditions likely to cause noticeable positioning errors

For various reasons, such as the state of the road you are traveling on and the reception status of the GPS signal, the actual position of your vehicle may differ from the position displayed on the map screen.

- If you make a shallow turn.

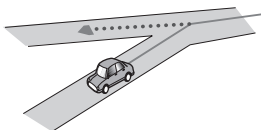

- If there is a parallel road.

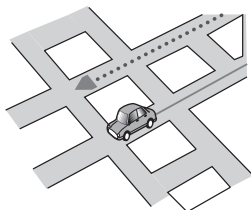

- If there is another road very nearby, such as in the case of an elevated freeway.

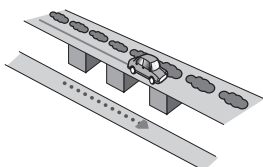

- If you take a recently opened road that is not on the map.

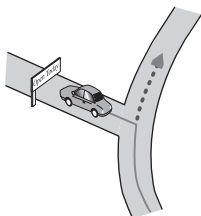

- If you drive in zigzags.

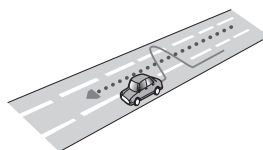

- If the road has a series of hairpin bends.

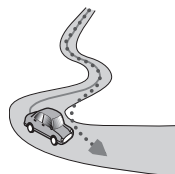

- If there is a loop or similar road configuration.

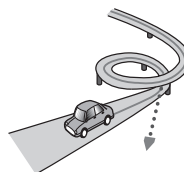

- If you take a ferry.

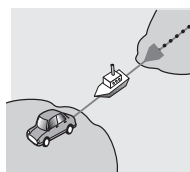

- If you are driving on a long, straight road or a gently curving road.

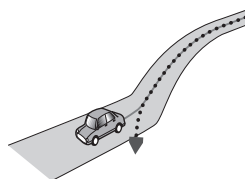

Appendix

- If you are on a steep mountain road with many height changes.

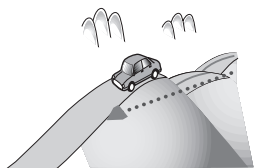

- If you enter or exit a multi storey parking lot or similar structure using a spiral ramp.

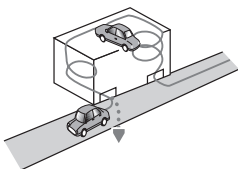

- If your vehicle is turned on a turntable or similar structure.

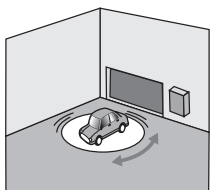

- If your vehicle's wheels spin, such as on a gravel road or in snow.



- If you put on chains, or change your tires for ones with a different size.

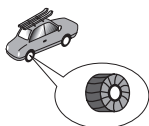

- If trees or other obstacles block the GPS signals for a considerable period.

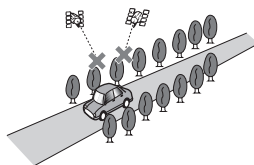

- If you drive very slowly, or in a start and stop manner, as in a traffic congestion.

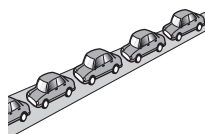

- If you join the road after driving around a large parking lot.

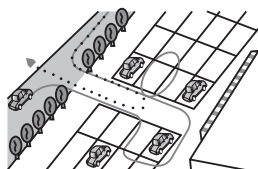

- When you drive around a traffic circle.

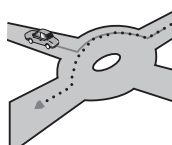

- When starting driving immediately after starting the engine.

Appendix

Route setting information

Route search specifications

Your navigation system sets a route to your destination by applying certain built in rules to the map data. This section provides some useful information about how a route is set.



CAUTION

When a route is calculated, the route and voice guidance for the route are automatically set. Also, for day or time traffic regulations, only information about traffic regulations applicable at the time when the route was calculated is considered. One way streets and street closures may not be taken into consideration. For example, if a street is open during the morning only, but you arrive later, it would be against the traffic regulations so you cannot drive along the set route. When driving, please follow the actual traffic signs. Also, the system may not know some traffic regulations.

- The calculated route is one example of the route to your destination decided by the navigation system while taking the type of streets or traffic regulations into account. It is not necessarily an optimum route. (In some cases, you may not be able to set the streets you want to take. If you need to take a certain street, set a waypoint on that street.)
- If the destination is too far, there may be instances where the route cannot be set. (If you want to set a long distance route going across several areas, set waypoints along the way.)
- During voice guidance, turns and intersections from the freeway are announced. However, if you pass intersections, turns, and other guidance points in rapid succession, some may delay or not be announced.
- It is possible that guidance may direct you off a freeway and then back on again.
- In some cases, the route may require you to travel in the opposite direction to your

current heading. In such cases, you are instructed to turn around, so please turn around safely by following the actual traffic rules.

- In some cases, a route may begin on the opposite side of a railway or river from your actual current location. If this happens, drive towards your destination for a while, and try route calculation again.
- When there is a traffic congestion ahead, a detour route may not be suggested if driving through the traffic congestion would still be better than taking the detour.
- There may be instances when the starting point, the waypoint and the destination point are not on the highlighted route.
- The number of traffic circle exits displayed on the screen may differ from the actual number of roads.

Route highlighting

- Once set, the route is highlighted in bright color on the map.
- The immediate vicinity of your starting point and destination may not be highlighted, and neither will areas with particularly complex road layouts. Consequently, the route may appear to be cut off on the display, but voice guidance will continue.

Auto reroute function

- If you deviate from the set route, the system will recalculate the route from that point so that you remain on track to the destination.
- This function may not work under certain conditions. 

Handling and care of discs

Some basic precautions are necessary when handling your discs.

Appendix

Built-in drive and care

- Use only conventional, fully circular discs. Do not use shaped discs.



- Do not use cracked, chipped, warped, or otherwise damaged discs as they may damage the built in drive.
- Do not touch the recorded surface of the discs.
- Store discs in their cases when not in use.
- Avoid leaving discs in excessively hot environments including under direct sunlight.
- Do not attach labels, write on or apply chemicals to the surface of the discs.
- To clean a disc, wipe it with a soft cloth, moving outward from the center.



- Condensation may temporarily impair the built in drive's performance. Leave it to adjust to the warmer temperature for about one hour. Also, wipe any damp discs with a soft cloth.
- Playback of discs may not be possible because of disc characteristics, disc format, recorded application, playback environment, storage conditions and so on.
- Road shocks may interrupt disc playback.
- Read the precautions for discs before using them.

Ambient conditions for playing a disc

- At extremely high temperatures, a temperature cutout protects this product by switching it off automatically.

- Despite our careful design of the product, small scratches that do not affect actual operation may appear on the disc surface as a result of mechanical wear, ambient conditions for use or handling of the disc. This is not a sign of the malfunction of this product. Consider it to be normal wear and tear. ■

Playable discs

DVD-Video and CD

DVD and CD discs that display the logos shown below generally can be played on this built in DVD drive.

DVD-Video



CD



- **DVD** is a trademark of DVD Format/Logo Licensing Corporation.
- It is not possible to play DVD Audio discs. This DVD drive may not be able to play all discs bearing the marks shown above.

AVCHD recorded discs

This unit is not compatible with discs recorded in AVCHD (Advanced Video Codec High Definition) format. Do not insert AVCHD discs. If inserted, the disc may not be ejected.

Appendix

Playing DualDisc

- DualDiscs are two sided discs that have a recordable CD for audio on one side and a recordable DVD for video on the other.
- Playback of the DVD side is possible with this navigation system. However, since the CD side of DualDiscs is not physically compatible with the general CD standard, it may not be possible to play the CD side with this navigation system.
- Frequent loading and ejecting of a Dual Disc may result in scratches to the disc.
- Serious scratches can lead to playback problems on this navigation system. In some cases, a DualDisc may become stuck in the disc loading slot and will not eject. To prevent this, we recommend you refrain from using DualDisc with this navigation system.
- Please refer to the manufacturer for more detailed information about DualDiscs.

Dolby Digital

This product will down mix Dolby Digital signals internally and the sound will be output in stereo.

- ☐ Manufactured under license from Dolby Laboratories. "Dolby" and the double D symbol are trademarks of Dolby Laboratories.



DTS sound

DTS audio format cannot be output, so select an audio track other than DTS audio format. "DTS" is registered trademarks of DTS, Inc. ☐

Detailed information for playable media

Compatibility

Common notes about disc compatibility

- Certain functions of this product may not be available for some discs.
- Compatibility with all discs is not guaranteed.
- It is not possible to playback DVD ROM/ DVD RAM discs.
- Playback of discs may become impossible with direct exposure to sunlight, high temperatures, or depending on the storage conditions in the vehicle.

DVD-Video discs

- DVD Video discs that have incompatible region numbers cannot be played on this DVD drive. The region number of the player can be found on this product's chassis.

DVD-R/DVD-RW/DVD-R DL (Dual Layer) discs

- Unfinalized discs which have been recorded with the Video format (video mode) cannot be played back. Discs which have been recorded with the Video Recording format (VR mode) cannot be played back.
- DVD R DL (Dual Layer) discs which have been recorded with Layer Jump recording cannot be played back.
- For detailed information about recording mode, please contact the manufacturer of media, recorders, or writing software.

CD-R/CD-RW discs

- Unfinalized discs cannot be played back.

Appendix

- It may not be possible to playback CD R/CD RW discs recorded on a music CD recorder or a personal computer because of disc characteristics, scratches or dirt on the disc, or dirt, scratches or condensation on the lens of the built in drive.
- Playback of discs recorded on a personal computer may not be possible, depending on the recording device, writing software, their settings, and other environmental factors.
- Please record with the correct format. (For details, please contact manufacturer of media, recorders, or writing software.)
- Titles and other text information recorded on a CD R/CD RW disc may not be displayed by this product (in the case of audio data (CD DA)).
- Read the precautions with CD R/CD RW discs before using them.

Common notes about the external storage device (USB, SD)

- Do not leave the external storage device (USB, SD) in any location with high temperatures.
- Depending on the kind of the external storage device (USB, SD) you use, this navigation system may not recognize the storage device or files may not be played back properly.
- The text information of some audio and video files may not be correctly displayed.
- File extensions must be used properly.
- There may be a slight delay when starting playback of files on an external storage device (USB, SD) with complex folder hierarchies.
- Operations may vary depending on the kind of an external storage device (USB, SD).
- It may not be possible to play some music files from SD or USB because of file characteristics, file format, recorded application, playback environment, storage conditions, and so on.

USB storage device compatibility

- For details about USB storage device compatibility with this navigation system, refer to *Specifications* on page 223.

Protocol: bulk

- You cannot connect a USB storage device to this navigation system via a USB hub.
- Partitioned USB memory is not compatible with this navigation system.
- Firmly secure the USB storage device when driving. Do not let the USB storage device fall onto the floor, where it may become jammed under the brake or gas pedal.
- There may be a slight delay when starting playback of audio files encoded with image data.
- Some USB storage devices connected to this navigation system may generate noise on the radio.
- Do not connect anything other than the USB memory device.

The sequence of audio files on USB memory

For USB memory, the sequence is different from that of USB memory device.

SD memory card and SDHC memory card

- For details about SD memory card compatibility with this navigation system, refer to *Specifications* on page 223.

Handling guidelines and supplemental information

- This system is not compatible with Multi Media Card (MMC).
- Copyright protected files cannot be played back.

Notes specific to DivX files

- Only DivX files downloaded from DivX partner sites are guaranteed for proper operation. Unauthorized DivX files may not operate properly.
- DRM rental files cannot be operated until playing back is started.

Appendix

- The navigation system corresponds to a DivX file display of up to 1 590 minutes 43 seconds. Search operations beyond this time limit are prohibited.
- DivX VOD file playback requires supplying the ID code of this navigation system to the DivX VOD provider. Regarding the ID code, refer to *Displaying your DivX VOD registration code* on page 171.
- Plays all versions of DivX video (including DivX 6) with standard playback of DivX media files.
- For more details about DivX, visit the following site:
<http://www.divx.com/>

DivX subtitle files

- Srt format subtitle files with the extension “.srt” can be used.
- Only one subtitle file can be used for each DivX file. Multiple subtitle files cannot be associated.
- Subtitle files that are named with the same character string as the DivX file before the extension are associated with the DivX file. The character strings before the extension must be exactly the same. However, if there is only one DivX file and one subtitle file in a single folder, the files are associated even if the file names are not the same.
- The subtitle file must be stored in the same folder as the DivX file.
- Up to 255 subtitle files may be used. Any more subtitle files will not be recognized.
- Up to 64 characters can be used for the name of the subtitle file, including the extension. If more than 64 characters are used for the file name, the subtitle file may not be recognized.
- The character code for the subtitle file should comply with ISO 8859 1. Using characters other than ISO 8859 1 may cause the characters to be displayed incorrectly.
- The subtitles may not be displayed correctly if the displayed characters in the subtitle file include control code.
- For materials that use a high transfer rate, the subtitles and video may not be completely synchronized.
- If multiple subtitles are programmed to display within a very short time frame, such as 0.1 seconds, the subtitles may not be displayed at the correct time.

Appendix

Media compatibility chart

General

Media	CD-R/-RW	DVD-R/-RW/-R DL	USB storage de- vice	SD memory card
File system	ISO9660 level 1, ISO9660 level 2, Romeo and Joliet	ISO9660 level 1, ISO9660 level 2, Romeo, Joliet and UDF 1.02	FAT16/FAT32	
Maximum number of folders	700		300	
Maximum number of files	999	3 500	2 500	
Playable file types	MP3, WMA, AAC, DivX		MP3, WMA, AAC, WAV, AVI, WMV, MPEG 4	
Note:	Maximum playback time of audio file stored in the external storage device (USB, SD): 7.5 h (450 minutes)			

MP3 compatibility

Media	CD-R/-RW	DVD-R/-RW/-R DL	USB storage de- vice	SD memory card
File extension	.mp3			
Bit rate	8 kbps to 320 kbps (CBR), VBR			
Sampling frequency	16 kHz to 48 kHz (32 kHz, 44.1 kHz, 48 kHz for emphasis)		8 kHz to 48 kHz	
ID3 tag	ID3 tag Ver. 1.0, 1.1, 2.2, 2.3		ID3 tag Ver. 1.0, 1.1, 2.2, 2.3, 2.4	
Notes:	<ul style="list-style-type: none"> Ver. 2.x of ID3 tag is given priority when both Ver. 1.x and Ver. 2.x exist. The navigation system is not compatible with the following: MP3i (MP3 interactive), mp3 PRO, m3u playlist 			

Appendix

WMA compatibility

Media	CD-R/-RW	DVD-R/-RW/-R DL	USB storage de- vice	SD memory card
File extension	.wma			
Bit rate	5 kbps to 320 kbps (CBR), VBR			
Sampling frequency	8 kHz to 48 kHz			
Note: The navigation system is not compatible with the following: Windows Media™ Audio 9 Professional, Lossless, Voice				

WAV compatibility

Media	CD-R/-RW	DVD-R/-RW/-R DL	USB storage de- vice	SD memory card
File extension	WAV files on the CD R/ RW, DVD R/ RW/ R DL cannot be played.		.wav	
Format			Linear PCM (LPCM), IMA ADPCM	
Sampling frequency			LPCM: 16 kHz to 48 kHz IMA ADPCM: 22.05 kHz and 44.1 kHz	
Quantization bits			LPCM: 8 bits and 16 bits MS ADPCM: 4 bits	
Note: The sampling frequency shown in the display may be rounded.				

AAC compatibility

Media	CD-R/-RW	DVD-R/-RW/-R DL	USB storage de- vice	SD memory card
File extension	.m4a			
Bit rate	8 kbps to 320 kbps (CBR)			
Sampling frequency	8 kHz to 44.1 kHz		8 kHz to 48 kHz	
Note: The navigation system plays back AAC files encoded by iTunes.				

Appendix

DivX compatibility

Media	CD-R/-RW	DVD-R/-RW/-R DL	USB storage device	SD memory card
File extension	.avi/.divx		DivX files on the external storage device (USB, SD) cannot be played.	
Profile (DivX version)	Home Theater Ver. 3.11/Ver. 4.x/Ver. 5.x/Ver. 6.x			
Compatible audio codec	MP3, Dolby Digital			
Bit rate (MP3)	8 kbps to 320 kbps (CBR), VBR			
Sampling frequency (MP3)	16 kHz to 48 kHz (32 kHz, 44.1 kHz, 48 kHz for emphasis)			
Maximum image size	720 pixels × 576 pixels			
Maximum file size	4 GB			
Notes:				
<ul style="list-style-type: none"> The navigation system is not compatible with the following: DivX Ultra format, DivX files without video data, DivX files encoded with LPCM (Linear PCM) audio codec Depending on the file information composition, such as the number of audio streams, there may be a slight delay in the start of playback on discs. If a file contains more than 4 GB, playback stops before the end. Some special operations may be prohibited because of the composition of DivX files. Files with high transfer rates may not be played back correctly. The standard transfer rate is 4 Mbps for CDs and 10.08 Mbps for DVDs. 				

Appendix

Video files compatibility (USB, SD)

File extension		.avi	.mp4, .m4v		.wmv
Format		MPEG 4	MPEG 4	H.264	WMV
Compatible video codec		MPEG 4	MPEG 4	H.264	WMV
Compatible audio codec		Linear PCM (LPCM), IMA ADPCM MP3	AAC	AAC	WMA
Recommended video specifications	Image size: QVGA (320 pixels x 240 pixels)	Bit rate: 768 kbps Frame rate: 30 fps	Bit rate: 768 kbps Frame rate: 30 fps	Bit rate: 384 kbps Frame rate: 30 fps	Bit rate: 384 kbps Frame rate: 30 fps
Maximum bit rate:	Image size: WQVGA (400 pixels x 240 pixels)	Bit rate: 2 Mbps Frame rate: 30 fps	Bit rate: 2 Mbps Frame rate: 30 fps	Bit rate: 1 Mbps Frame rate: 30 fps	Bit rate: 768 kbps Frame rate: 30 fps
	Image size: VGA (640 pixels x 480 pixels)	Bit rate: 1 Mbps Frame rate: 30 fps	Bit rate: 1 Mbps Frame rate: 30 fps	Bit rate: 576 kbps Frame rate: 30 fps	Bit rate: 576 kbps Frame rate: 30 fps
Maximum file size		2 GB			
Maximum playback time		150 minutes			

Common notes

- The navigation system may not operate correctly, depending on the application used to encode WMA files.
- Depending on the version of Windows Media™ Player used to encode WMA files, album names and other text information may not be correctly displayed.
- There may be a slight delay when starting playback of audio files encoded with image data.
- The navigation system is not compatible with packet write data transfer.
- This navigation system can recognize up to 32 characters, beginning with the first character, including extension for the file and folder name. Depending on the display area, the navigation system may try to display them with a reduced font size. However, the maximum number of the characters that you can display varies ac-

ording to the width of each character, and of the display area.

- Folder selection sequence or other operations may be altered, depending on the encoding or writing software.
- Regardless of the length of blank section between the songs of original recording, compressed audio discs play with a short pause between songs.

Appendix

Example of a hierarchy

The following figure is an example of the tier structure in the disc. The numbers in the figure indicate the order in which folder numbers are assigned and the order to be played back.

 Folder

 File

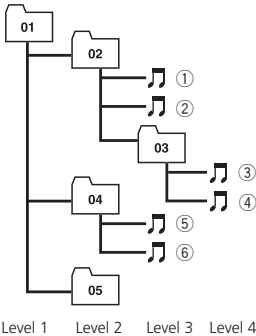

Notes

- This product assigns folder numbers. The user cannot assign folder numbers.
- If there is a folder that does not contain any playable file, the folder itself will display in the folder list but you cannot check any files in the folder. (A blank list will appear.) Also, these folders will be skipped without displaying the folder number. 

Bluetooth



Bluetooth is a short range wireless radio connectivity technology that is developed as a cable replacement for cellular phones, hand held PCs and other devices. Bluetooth operates in 2.4 GHz frequency range and transmits voice and data at speeds up to 1 megabit per

second. Bluetooth was launched by a special interest group (SIG) comprising Ericsson Inc., Intel Corp., Nokia Corp., Toshiba and IBM in 1998, and it is currently developed by nearly 2000 companies worldwide.

- The *Bluetooth*[®] word mark and logos are registered trademarks owned by Bluetooth SIG, Inc. and any use of such marks by Pioneer Corporation is under license. Other trademarks and trade names are those of their respective owners. 

About the SAT RADIO READY Logo



The SAT RADIO READY logo indicates that the Satellite Radio Tuner for Pioneer (i. e., XM tuner and Sirius satellite tuner which are sold separately) can be controlled by this navigation system. Please inquire with your dealer or nearest authorized Pioneer service station regarding the satellite radio tuner that can be connected to this navigation system.

Note:

The system will use direct satellite to receive broadcasting technology to provide listeners in their cars and at home with crystal clear sound seamlessly from coast to coast. Satellite radio will create and package over 100 channels of digital quality music, news, sports, talk and children's programming. "SAT Radio", the SAT Radio logo and all related marks are trademarks of Sirius Satellite Radio inc., and XM Satellite Radio Inc. 

HD Radio Technology

HD Radio[™] and the HD and HD Radio Ready logos are proprietary trademarks of iBiquity Digital Corporation. 

Appendix

SD and SDHC logo



SD Logo is a trademark of SD 3C, LLC.



SDHC Logo is a trademark of SD 3C, LLC.



microSD Logo is a trademark of SD 3C, LLC.



microSDHC Logo is a trademark of SD 3C, LLC. □

WMA/WMV



Windows Media™ and the Windows logo are trademarks or registered trademarks of Microsoft Corporation in the United States and/or other countries. □

DivX



DivX is a compressed digital video format created by the DivX video codec from DivX, Inc. This unit can play DivX video files recorded on CD R/RW/ROM and DVD R/RW/ROM discs. Keeping the same terminology as DVD video, individual DivX video files are called "Titles". When naming files/titles on a CD R/RW or a DVD R/RW disc prior to burning, keep in mind that by default they will be played in alphabetical order.

For U.S.A.

DivX® is a registered trademark of DivX, Inc., and is used under license.

For Canada

DivX™ is a registered trademark of DivX, Inc., and is used under license.

ABOUT DIVX VIDEO: DivX® is a digital video format created by DivX, Inc. This is an official DivX Certified device that plays DivX video. Visit www.divx.com for more information and software tools to convert your files into DivX video.

ABOUT DIVX VIDEO-ON-DEMAND: This DivX® Certified device must be registered in order to play DivX Video on Demand (VOD) content. To generate the registration code, locate the DivX VOD section in *Displaying your DivX VOD registration code*. Go to vod.divx.com with this code to complete the registration process and learn more about DivX VOD.

➔ For details, refer to *Displaying your DivX VOD registration code* on page 171. □

Appendix

AAC

AAC is short for Advanced Audio Coding and refers to an audio compression technology standard used with MPEG 2 and MPEG 4. Several applications can be used to encode AAC files, but file formats and extensions differ depending on the application which is used to encode. This unit plays back AAC files encoded by iTunes version 7.7. 

Detailed information regarding connectable iPods

CAUTION

- Pioneer accepts no responsibility for data lost from an iPod, even if that data is lost while using the navigation system.
- Do not leave the iPod in direct sunlight for extended amounts of time. Extended exposure to direct sunlight can result in iPod malfunction due to the resulting high temperature.
- Do not leave the iPod in any location with high temperatures.
- Firmly secure the iPod when driving. Do not let the iPod fall onto the floor, where it may become jammed under the brake or gas pedal.

For details, refer to the iPod's manuals.

iPod



"Made for iPod" means that an electronic accessory has been designed to connect specifically to iPod and has been certified by the developer to meet Apple performance standards.

Apple is not responsible for the operation of this device or its compliance with safety and regulatory standards.

iPod is a trademark of Apple Inc., registered in the U.S. and other countries.

iPhone



"Works with iPhone" means that an electronic accessory has been designed to connect specifically to iPhone and has been certified by the developer to meet Apple performance standards.

Apple is not responsible for the operation of this device or its compliance with safety and regulatory standards.

iPhone is a trademark of Apple Inc.

iTunes

iTunes is a trademark of Apple Inc., registered in the U.S. and other countries. 

Using the LCD screen correctly

Handling the LCD screen

- When the LCD screen is subjected to direct sunlight for a long period of time, it will become very hot, resulting in possible damage to the LCD screen. When not using this navigation system, avoid exposing it to direct sunlight as much as possible.
- The LCD screen should be used within the temperature ranges shown in *Specifications*.

Appendix

- Do not use the LCD screen at temperatures higher or lower than the operating temperature range, because the LCD screen may not operate normally and could be damaged.
- The LCD screen is exposed in order to increase its visibility within the vehicle. Please do not press strongly on it as this may damage it.
- Do not push the LCD screen with excessive force as this may scratch it.
- Never touch the LCD screen with anything besides your finger when operating the Touch panel functions. The LCD screen can scratch easily.

Liquid crystal display (LCD) screen

- If the LCD screen is near the vent of an air conditioner, make sure that air from the air conditioner is not blowing on it. Heat from the heater may break the LCD screen, and cool air from the cooler may cause moisture to form inside the navigation unit, resulting in possible damage.
- Small black dots or white dots (bright dots) may appear on the LCD screen. These are due to the characteristics of the LCD screen and do not indicate a malfunction.
- The LCD screen will be difficult to see if it is exposed to direct sunlight.
- When using a cellular phone, keep the antenna of the cellular phone away from the LCD screen to prevent disruption of the video in the form of disturbances such as spots or colored stripes.

Maintaining the LCD screen

- When removing dust from the LCD screen or cleaning it, first turn the system power off, then wipe with a soft dry cloth.
- When wiping the LCD screen, take care not to scratch the surface. Do not use harsh or abrasive chemical cleaners.

LED (light-emitting diode) backlight

A light emitting diode is used inside the display to illuminate the LCD screen.

- At low temperatures, using the LED backlight may increase image lag and degrade the image quality because of the characteristics of the LCD screen. Image quality will improve with an increase in temperature.
- The product lifetime of the LED backlight is more than 10 000 hours. However, it may decrease if used in high temperatures.
- If the LED backlight reaches the end of its product lifetime, the screen will become dimmer and the image will no longer be visible. In that case, please consult your dealer or the nearest authorized Pioneer Service Station. 

Appendix

Display information

Destination Menu

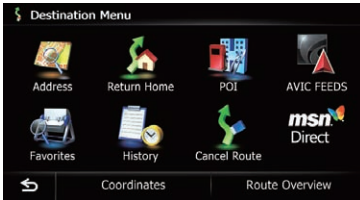

	Page
Address	34
Return Home	36
POI	
Gas Station	
ATM	36
Coffee	
Hotel	
Spell Name	37
Near Me	37
Near Destination	38
Around City	38
AVIC FEEDS	39
Favorites	39, 46
History	39, 49
Cancel Route	45
MSN Direct	50
Coordinates	40
Route Overview	42

Phone Menu

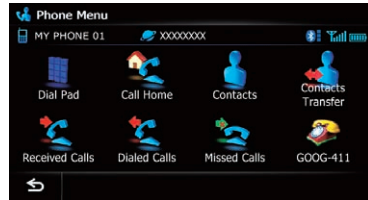

	Page
Dial Pad	68
Call Home	69
Contacts	69
Contacts Transfer	72
Received Calls	69
Dialed Calls	69
Missed Calls	69
GOOG-411	70

Appendix

Settings Menu

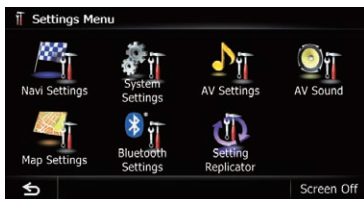

	Page
Navi Settings	148
System Settings	161
AV Settings	168
AV Sound	171
Map Settings	154
Bluetooth Settings	73
Setting Replicator	176

Navi Settings menu

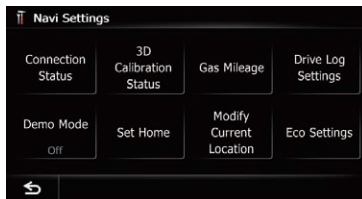

	Page
Connection Status	148
3D Calibration Status	149
Gas Mileage	150
Drive Log Settings	152
Demo Mode	152
Set Home	152
Modify Current Location	153
Eco Settings	153

Appendix

System Settings menu

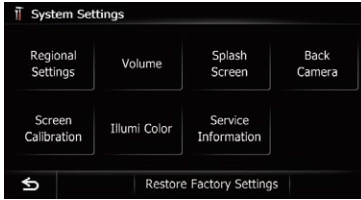

	Page
Regional Settings	
Program Language, Voice Language	161
Time	162
km / mile	162
Average Speed	162
Volume	163
Splash Screen	163
Back Camera	164
Screen Calibration	165
Illumi Color	165
Service Information	166
Restore Factory Settings	188

Map Settings menu

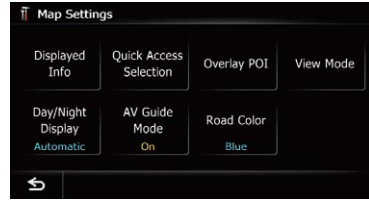

	Page
Displayed Info	
Close Up View	154
City Map	155
City Map Barrier	155
Show Traffic Incident	155
Bluetooth Connected	156
Current Street Name	156
Favorites Icon	156
3D Land Mark	156
Show Maneuver	157
MSN Direct	157
Show Eco Meter	157
Quick Access Selection	160
Overlay POI	157
View Mode	29
Day/Night Display	159
AV Guide Mode	160
Road Color	159

Appendix

AV System Settings menu

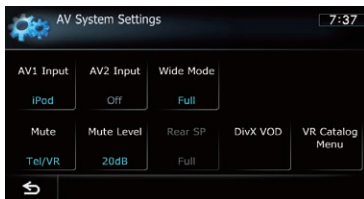

	Page
AV1 Input	168
AV2 Input	168
Wide Mode	169
Mute	170
Mute Level	170
Rear SP	169
DivX VOD	171
VR Catalog Menu	170

AV Sound Settings menu



	Page
FAD/BAL (Balance)	172
EQ	172
Loudness	174
Sub Woofer	174
HPF	175
SLA	175
Bass Booster	175
Staging	175

Appendix

Bluetooth Settings menu

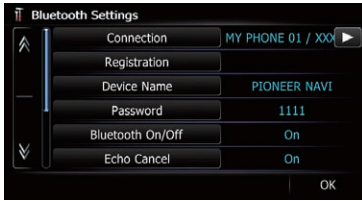

	Page
Connection	66
Registration	63
Device Name	73
Password	73
Bluetooth On/Off	73
Echo Cancel	74
Auto Answer Preference	74
Refuse All Calls	74
Clear Memory	75
Firmware update	75



Appendix

Glossary

AAC

AAC is short for Advanced Audio Coding and refers to an audio compression technology standard used with MPEG 2 and MPEG 4.

Aspect ratio

This is the width to height ratio of a TV screen. A regular display has an aspect ratio of 4:3. Wide screen displays have an aspect ratio of 16:9, providing a bigger picture for exceptional presence and atmosphere.

Bit rate

This expresses data volume per second, or bps units (bits per second). The higher the rate, the more information is available to reproduce the sound. Using the same encoding method (such as MP3), the higher the rate, the better the sound.

Built-in sensor

The built in sensor that enables the system to estimate your vehicle's position.

CD-DA

This stands for a general music CD (commercial release audio CD). In this manual, this word is sometime used for a distinction between data CDs (which include compressed audio files) and general music CDs.

Chapter

Titles of DVD Video are in turn divided into chapters which are numbered in the same way as the chapters of a book. With discs featuring chapters, you can quickly find a desired scene with chapter search.

Current location

The present location of your vehicle; your current location is shown on the map by a red triangle mark.

Destination

A location you choose as the end point of your journey.

DivX

DivX is a popular media technology created by DivX, Inc. DivX media files contain highly compressed video with high visual quality that maintains a relatively small file size. DivX files can also include advanced media features like menus, subtitles, and alternate audio tracks. Many DivX media files are available for download online, and you can create your own using your personal content and easy to use tools from DivX.com.

DivX Certified

DivX Certified products are officially tested by the creators of DivX and guaranteed to play all versions of DivX video, including DivX 6.

Favorites

A frequently visited location (such as your workplace or a relative's home) that you can register to allow easy routing.

GPS

Global Positioning System. A network of satellites that provides navigation signals for a variety of purposes.

Guidance mode

The mode in which guidance is given as you drive to your destination; the system automatically switches to this mode as soon as a route has been set.

Guidance point

These are important landmarks along your route, generally intersections. The next guidance point along your route is indicated on the map by the yellow flag icon.

Home location

Your registered home location.

Appendix

ID3 tag

This is a method of embedding track related information in an MP3 file. This embedded information can include the track title, the artist's name, the album title, the music genre, the year of production, comments and other data. The contents can be freely edited using software with ID3 tag editing functions.

Although the tags are restricted by the number of characters, the information can be viewed when the track is played back.

ISO 9660 format

This is the international standard for the format logic of DVD/CD ROM folders and files. For the ISO9660 format, there are regulations for the following two levels:

- **Level 1:**
The file name is in 8.3 format (the name consists of up to eight characters, half byte English capital letters, half byte numerals and the " " sign, with a file extension of three characters).
- **Level 2:**
The file name can have up to 31 characters (including the separation mark "." and a file extension). Each folder contains less than eight hierarchies.
- **Extended formats**
Joliet:
File names can have up to 64 characters.
Romeo:
File names can have up to 128 characters.

JPEG

This stands for Joint Photographic Experts Group, and is an international still image compression standard.

MP3

MP3 is short for MPEG Audio Layer 3. It is an audio compression standard established by a working group (MPEG) of the ISO (International Organization for Standardization). MP3 is able to compress audio data to about 1/10th the size of a conventional disc.

MPEG

This stands for Moving Pictures Experts Group, and is an international video image compression standard.

Multi-angle

With regular TV programs, although multiple cameras are used to simultaneously shoot scenes, only images from one camera at a time are transmitted to your TV. Some DVDs feature scenes shot from multiple angles, letting you choose your viewing angle as desired.

Multi-audio (Multilingual dialog)

Some videos feature dialog recorded in multiple languages or audio recorded in multiple tracks. For example, dialog in up to eight languages can be recorded on a single DVD Video, letting you choose the language as desired.

Multi-session

Multi session is a recording method that allows additional data to be recorded later. When recording data on a CD ROM, CD R or CD RW, etc., all data from beginning to end is treated as a single unit or session. Multi session is a method of recording more than two sessions in one disc.

Multi-subtitle

For example, subtitles in up to 32 languages can be recorded on a single DVD Video, letting you choose as desired.

Packet write

This is a general term for a method of writing individual files to a CD R, etc. whenever required, just as is done with files on floppy or hard disks.

Appendix

Parental lock

Some DVD Video discs with violent or adult oriented scenes feature parental lock which prevents children from viewing such scenes. With this kind of disc, if you set the unit's parental lock level, playback of scenes inappropriate for children will be disabled, or these scenes will be skipped.

Phone book

An address book on user's phone is collectively referred to as "Phone book". Depending on the cellular phone, the phone book may be called a name such as "Contacts", "Business card" or something else.

Point Of Interest (POI)

Any of a range of locations stored in the data, such as railway stations, shops, restaurants, and amusement parks.

Region number

DVD players and DVD discs feature region numbers indicating the area in which they were purchased. Playback of a DVD is not possible unless it features the same region number as the DVD player.

Route setting

The process of determining the ideal route to a specific location; route setting is done automatically by the system when you specify a destination.

Set route

The route marked out by the system to your destination. It is highlighted in bright color on the map.

Title

DVD Video discs have a high data capacity, enabling recording of multiple videos on a single disc. If, for example, one disc contains three separate videos, they are divided into title 1, title 2 and title 3. This lets you enjoy the convenience of title search and other functions.

Track log

Your navigation system logs routes that you already passed through if the track logger is activated. This recorded route is called a "track log". It is handy when you want to check a route traveled or if returning along a complex route.

VBR

VBR is short for variable bit rate. Generally speaking, CBR (constant bit rate) is more widely used. But by flexibly adjusting the bit rate according to the needs of audio compression, it is possible to achieve compression priority sound quality.

Voice guidance

The giving of directions by navigation voice while in guidance.

Waypoint

A location that you choose to visit before your destination; a journey can be built up from multiple waypoints and the destination.

WMA

WMA is short for Windows Media™ Audio and refers to an audio compression technology that is developed by Microsoft Corporation. WMA data can be encoded by using Windows Media Player version 7 or later. ■

Appendix

Specifications

General

Rated power source	14.4 V DC (allowable voltage range: 10.8 V to 15.1 V DC)
Grounding system	Negative type
Maximum current consumption	10.0 A
Dimensions (W × H × D):	
AVIC Z120BT	
Chassis	178 mm × 100 mm × 165 mm (7 in. × 3 7/8 in. × 6 1/2 in.)
Nose	170 mm × 96 mm × 17 mm (6 3/4 in. × 3 3/4 in. × 5/8 in.)
AVIC X920BT	
Chassis	178 mm × 100 mm × 165 mm (7 in. × 3 7/8 in. × 6 1/2 in.)
Nose	170 mm × 96 mm × 11 mm (6 3/4 in. × 3 3/4 in. × 3/8 in.)
Weight:	
AVIC Z120BT	2.43 kg (5.3 lbs)
AVIC X920BT	2.01 kg (4.4 lbs)
NAND flash memory	4 GB

Navigation

GPS receiver:	
System	L1, C/Acode GPS SPS (Standard Positioning Service)
Reception system	32 channel multi channel reception system
Reception frequency ...	1 575.42 MHz
Sensitivity	140 dBm (typ)
Position update frequency	Approx. once per second
GPS antenna:	
Antenna	Micro strip flat antenna/ right handed helical polari- zation
Antenna cable	3.55 m (11 ft. 7 in.)
Dimensions (W × H × D)	33 mm × 15 mm × 36 mm (1 1/4 in. × 5/8 in. × 1 3/8 in.)
Weight	73.7 g (0.16 lbs)

Display

Screen size/aspect ratio:	
AVIC Z120BT	7 inch wide/16:9

AVIC X920BT	6.1 inch wide/16:9
Effective display area:	
AVIC Z120BT	159 mm × 84 mm
AVIC X920BT	138 mm × 73 mm
Pixels	384 000 (800 × 480)
Display method	TFT Active matrix driving
Backlight	LED
Color system	NTSC compatible
Tolerable temperature range:	
Power on	+14 °F to +140 °F
Power off	4 °F to +176 °F
Angle adjustment	
AVIC Z120BT	0° to 22°
AVIC X920BT	0°

Audio

Maximum power output	50 W × 4 50 W × 2 ch/4Ω + 70 W × 1 ch/2Ω (for subwoofer)
Continuous power output ...	22 W × 4 (50 Hz to 15 kHz, 5%THD, 4Ω LOAD, Both Channels Driven)
Load impedance	4Ω (4Ω to 8Ω [2Ω for 1 ch] allowable)
Preout output level (max):	
AVIC Z120BT	4.0 V
AVIC X920BT	2.2 V
Preout impedance:	
AVIC Z120BT	100 ohm
AVIC X920BT	1 kohm
Equalizer (7 Band Graphic Equalizer):	
Frequency	50 Hz/125 Hz/315 Hz/800 Hz/ 2 kHz/5 kHz/12.5 kHz
Gain	±12 dB
Loudness contour:	
Low	+3.5 dB (100 Hz), +3 dB (10 kHz)
Mid	+10 dB (100 Hz), +6.5 dB (10 kHz)
High	+11 dB (100 Hz), +11 dB (10 kHz) (volume: 30 dB)
HPF:	
Frequency	50 Hz/63 Hz/80 Hz/100 Hz/ 125 Hz
Slope	12 dB/oct
Subwoofer:	
Frequency	50 Hz/63 Hz/80 Hz/100 Hz/ 125 Hz
Slope	18 dB/oct
Gain	24/+6 dB
Phase	Normal/Reverse
Bass boost:	
Gain	0 dB to +12 dB

Appendix

DVD Drive

System	DVD Video, CD, MP3, WMA, AAC, DivX system
Usable discs	DVD Video, DVD R(DL), DVD RW, CD ROM, CD DA, CD R/RW
Region number	1
Signal format:	
Sampling frequency	44.1 kHz/48 kHz/96 kHz
Number of quantization bits	16 bit/20 bit/24 bit; linear
Frequency response	5 Hz to 44 000 Hz (with DVD, at sampling frequency 96 kHz)
Signal to noise ratio	97 dB (1 kHz) (IEC A network) (CD: 96 dB (1 kHz) (IEC A network))
Dynamic range	95 dB (1 kHz) (CD: 94 dB (1 kHz))
Distortion	0.008 % (1 kHz)
Output level:	
Video	1.0 Vp p/75 Ω (± 0.2 V)
Audio	1.0 V (1 kHz, 0 dB)
Number of channels	2 (stereo)
MP3 decoding format	MPEG 1 & 2 Audio Layer 3
WMA decoding format	Ver.9.0 L3
AAC decoding format	MPEG 4 AAC (only encoded by iTunes): .m4a
DivX decoding format	Home Theater Ver.3.11, Ver.4.X, Ver.5.X, Ver.6.X: .avi, .divx

USB

USB standard spec.	USB 2.0 High Speed
Max current supply	500 mA
File system	FAT16, FAT32
USB class	Mass storage class
Decoding format	MP3/WMA/AAC/WAVE/ H.264/MPEG4/WMV

SD (AVIC-Z120BT)

SD memory card, SDHC memory card	
Compatible physical format	Version 2.00
Max memory capacity	16 GB
File system	FAT16, FAT32
Decoding format	MP3/WMA/AAC/WAVE/ H.264/MPEG4/WMV

SD (AVIC-X920BT)

microSD card, microSDHC card	
Compatible physical format	Version 2.00
Max memory capacity	16 GB
File system	FAT16, FAT32
Decoding format	MP3/WMA/AAC/WAVE/ H.264/MPEG4/WMV

Bluetooth

Version	Bluetooth 2.0+EDR
Output power	+4 dBm Max. (Power class 2)

FM tuner

Frequency range	87.9 MHz to 107.9 MHz
Usable sensitivity	9 dBf (0.8 μ V/75 Ω , mono, S/N: 30 dB)
Signal to noise ratio	72 dB (IEC A network)
Distortion	0.3 % (at 65 dBf, 1 kHz, stereo) 0.1 % (at 65 dBf, 1 kHz, mono)
Frequency response	30 Hz to 15 000 Hz (± 3 dB)
Stereo separation	45 dB (at 65 dBf, 1 kHz)

AM tuner

Frequency range	530 kHz to 1 710 kHz (10 kHz)
Usable sensitivity	25 μ V (S/N: 20 dB)
Signal to noise ratio	62 dB (IEC A network)

CEA2006 Specifications



Power output	14 W RMS \times 4 Channels (4 Ω and $\leq 1\%$ THD+N)
S/N ratio	91 dBA (reference: 1 W into 4 Ω)



Note

Specifications and design are subject to possible modifications without notice due to improvements.

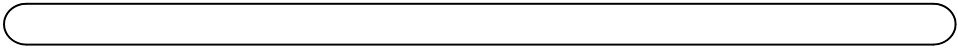

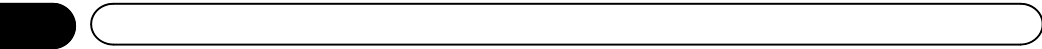



Register your product at

<http://www.pioneerelectronics.com>

in Canada **<http://www.pioneerelectronics.ca>**

See "Visit our website" page

PIONEER CORPORATION

1-1, Shin-ogura, Saiwai-ku, Kawasaki-shi,
Kanagawa 212-0031, JAPAN

PIONEER ELECTRONICS (USA) INC.

P.O. Box 1540, Long Beach, California 90801-1540, U.S.A.
TEL: (800) 421-1404

PIONEER EUROPE NV

Haven 1087, Keetberglaan 1, B-9120 Melsele, Belgium/Belgique
TEL: (0) 3/570.05.11

PIONEER ELECTRONICS ASIACENTRE PTE. LTD.

253 Alexandra Road, #04-01, Singapore 159936
TEL: 65-6472-7555

PIONEER ELECTRONICS AUSTRALIA PTY. LTD.

178-184 Boundary Road, Braeside, Victoria 3195, Australia
TEL: (03) 9586-6300

PIONEER ELECTRONICS OF CANADA, INC.

300 Allstate Parkway, Markham, Ontario L3R 0P2, Canada
TEL: 1-877-283-5901
TEL: 905-479-4411

PIONEER ELECTRONICS DE MEXICO, S.A. de C.V.

Bldv.Manuel Avila Camacho 138 10 piso
Col.Lomas de Chapultepec, Mexico, D.F. 11000
TEL: 55-9178-4270

先鋒股份有限公司

總公司：台北市中山北路二段44號13樓
電話：(02) 2521-3588

先鋒電子（香港）有限公司

香港九龍尖沙咀海港城世界商業中心9樓901-6室
電話：(0852) 2848-6488

Published by Pioneer Corporation.

Copyright © 2010 by Pioneer Corporation.
All rights reserved.